

01: SPIM-NAND (SPI2)

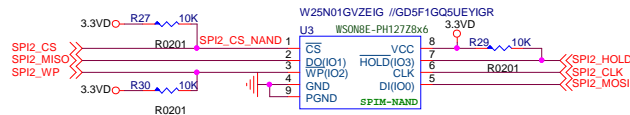

02:eMMC

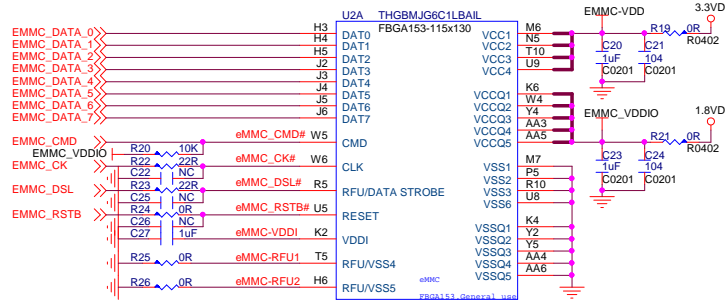

Boot Strapping

Pin Name	Description	Boot Sequence
{GPIO_1,GPIO_0}	Boot mode	00: SPIM-NOR (SPI2) 01: SPIM-NAND (SPI2)
{GPIO_3}	A-Die Mode	0: 2 A-Die/1 Adie 8B 1: 1 A-die DBDC
UART_TX0	Second A Die Xtal mode	0: XTAL mode 1: Buffer mode
PWM0	40MHz/80MHz Xtal select	0: Reserved 1: 40MHz
SYS_WATCHDOG	CPU 1.023V/0.85V select	0: 0.85V 1: 1.023V

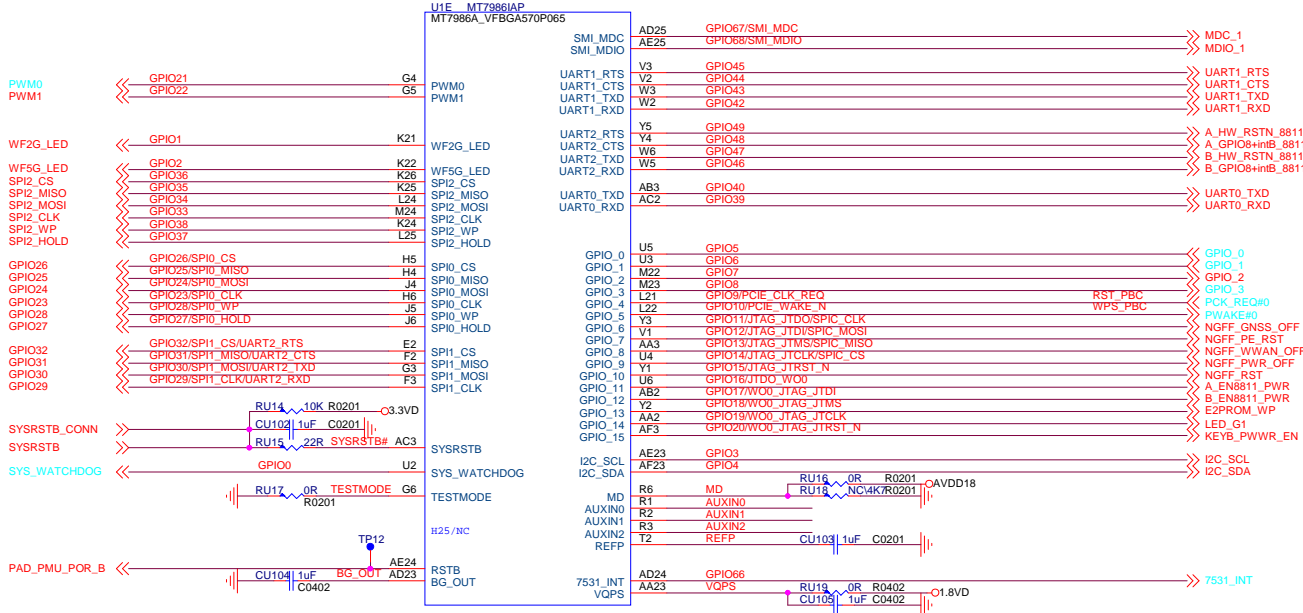
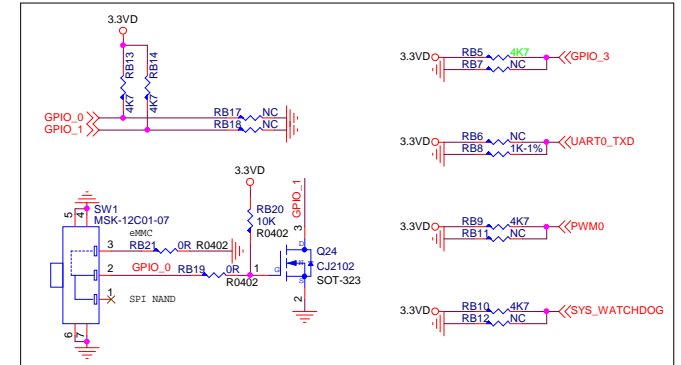

GUANGDONG BIPAI KEJI CPA.LTD

BPI-R3mini-reduce

Size A3	Page Name CM04_MT7986_CONSYS	Rev V1.0
Date:	Friday, May 26, 2023	Sheet 4 of 13

Power on sequence

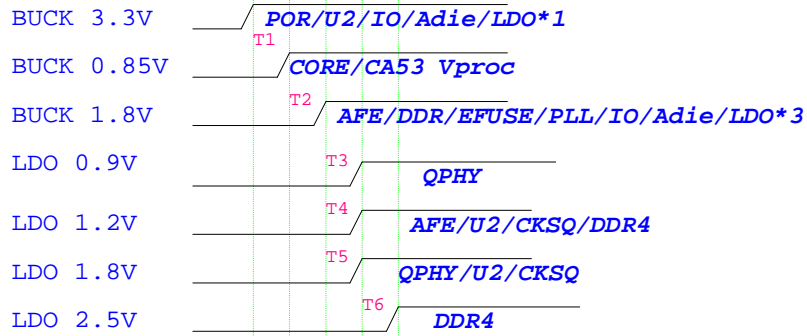

1.8VD: 1.8V/6A

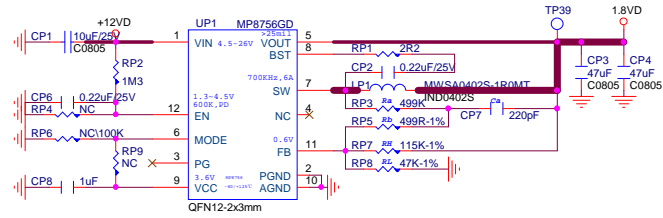

LDO 0.9V/300mA

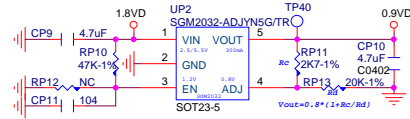

3.3VD: 3.3V/8A

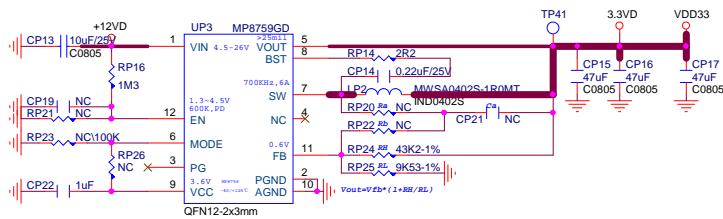

LDO 1.8V/300mA

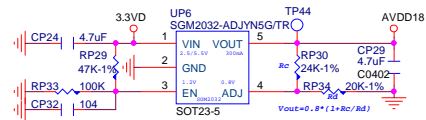

CORE: 0.85V/6A

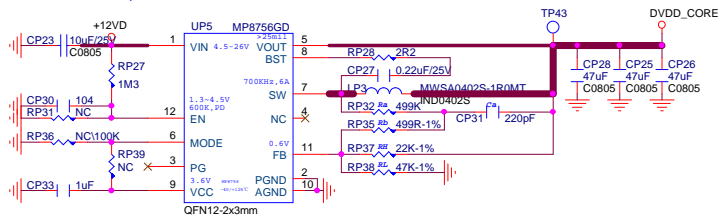

LDO 1.2V/500mA

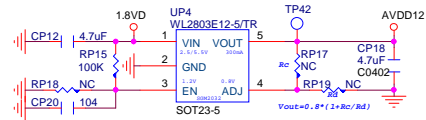

CA53 Core: 1.024V/6A

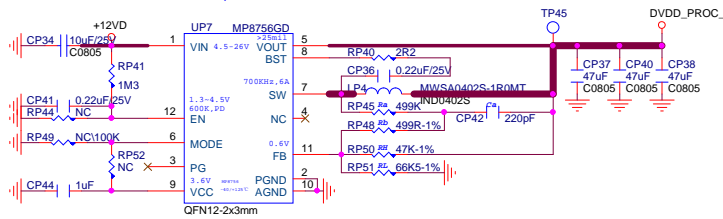

LDO 2.5V/300mA

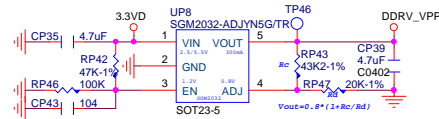

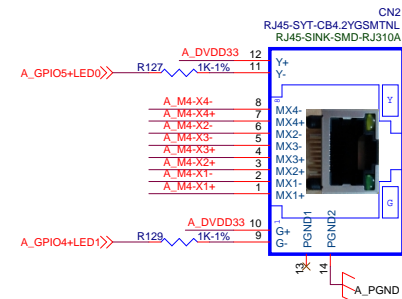
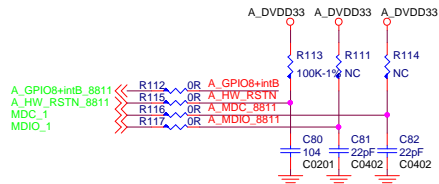
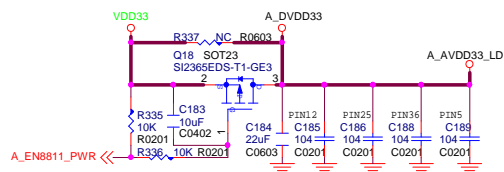
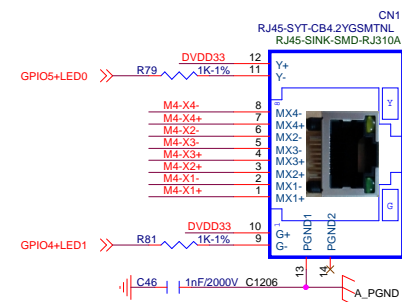
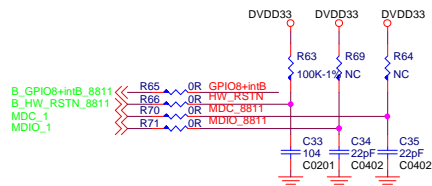
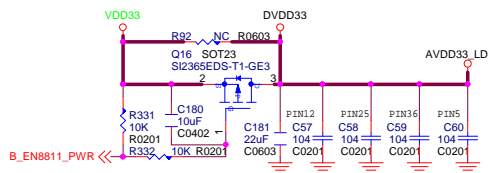

1.8VD
VDD33
+12VD

NGFF_PWR_OFF <<>> R208 0R R0201 FULL_CARD_POWER_OFF#
 NGFF_WWAN_OFF <<>> R200 0R R0201 WWAN_DISABLE1#
 NGFF_GNSS_OFF <<>> R201 0R R0201 GNSS_DISABLE2#
 NGFF_PE_RST <<>> R205 0R R0201 NGFF-PERST#

GPIO32 <<>> GPIO32/SPI1_CS/UART2_RTS KEYB_GPIO32
 GPIO31 <<>> GPIO31/SPI1_MISO/UART2_CTS KEYB_GPIO31
 GPIO30 <<>> GPIO30/SPI1_MOSI/UART2_TXD KEYB_GPIO30
 GPIO29 <<>> GPIO29/SPI1_CLK/UART2_RXD KEYB_GPIO29

SYSRSTB_CONN <<>> R398 NC R0201 KEYB_SYSRST
 7531_INT <<>> R399 0R R0201 KEYB_7531_INT
 AUXIN1 <<>> R203 0R R0201 KEYB_ID1

NGFF_RST <<>> D13 B5819WS NGFF_RSTN_V1P8
 SOD323

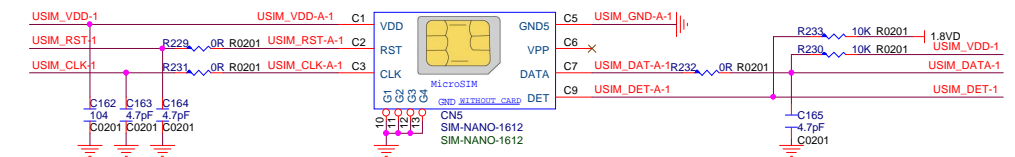
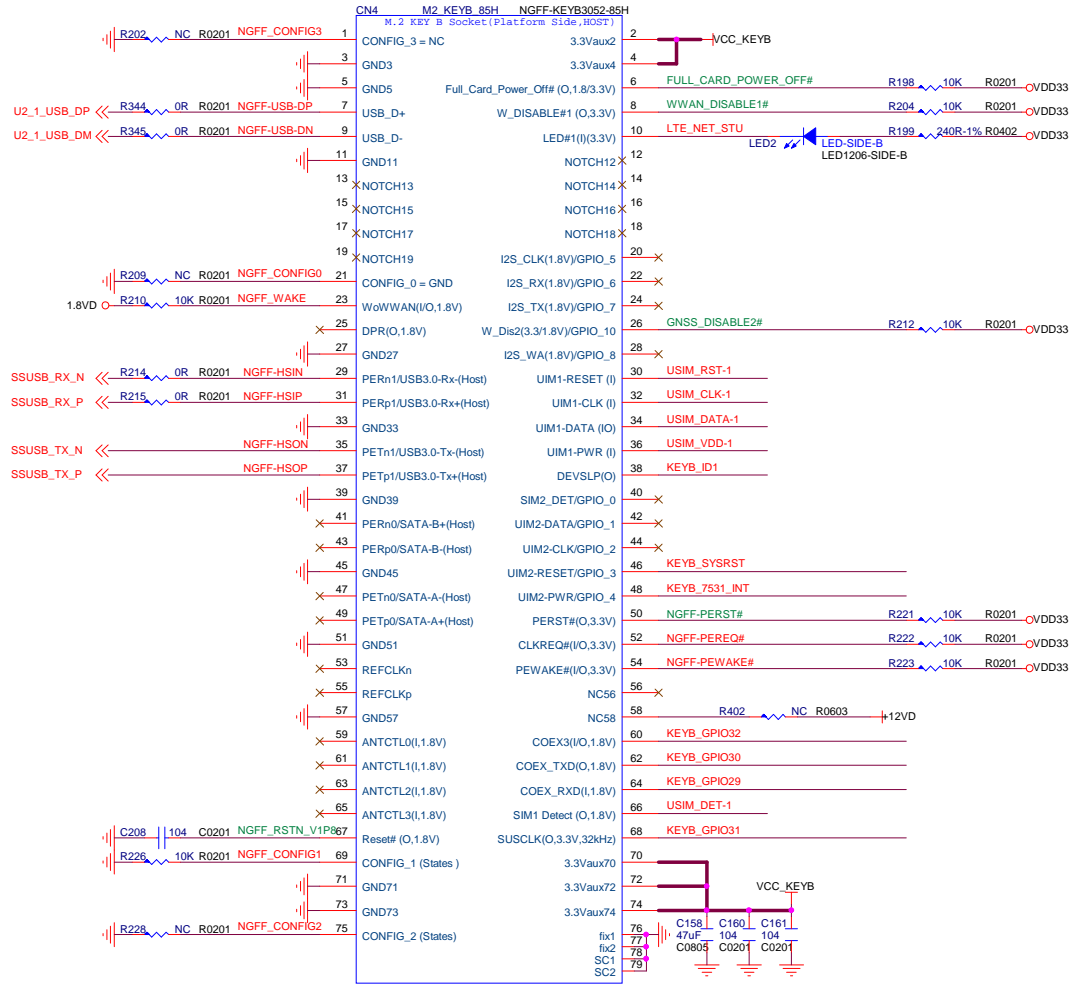
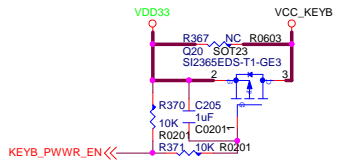

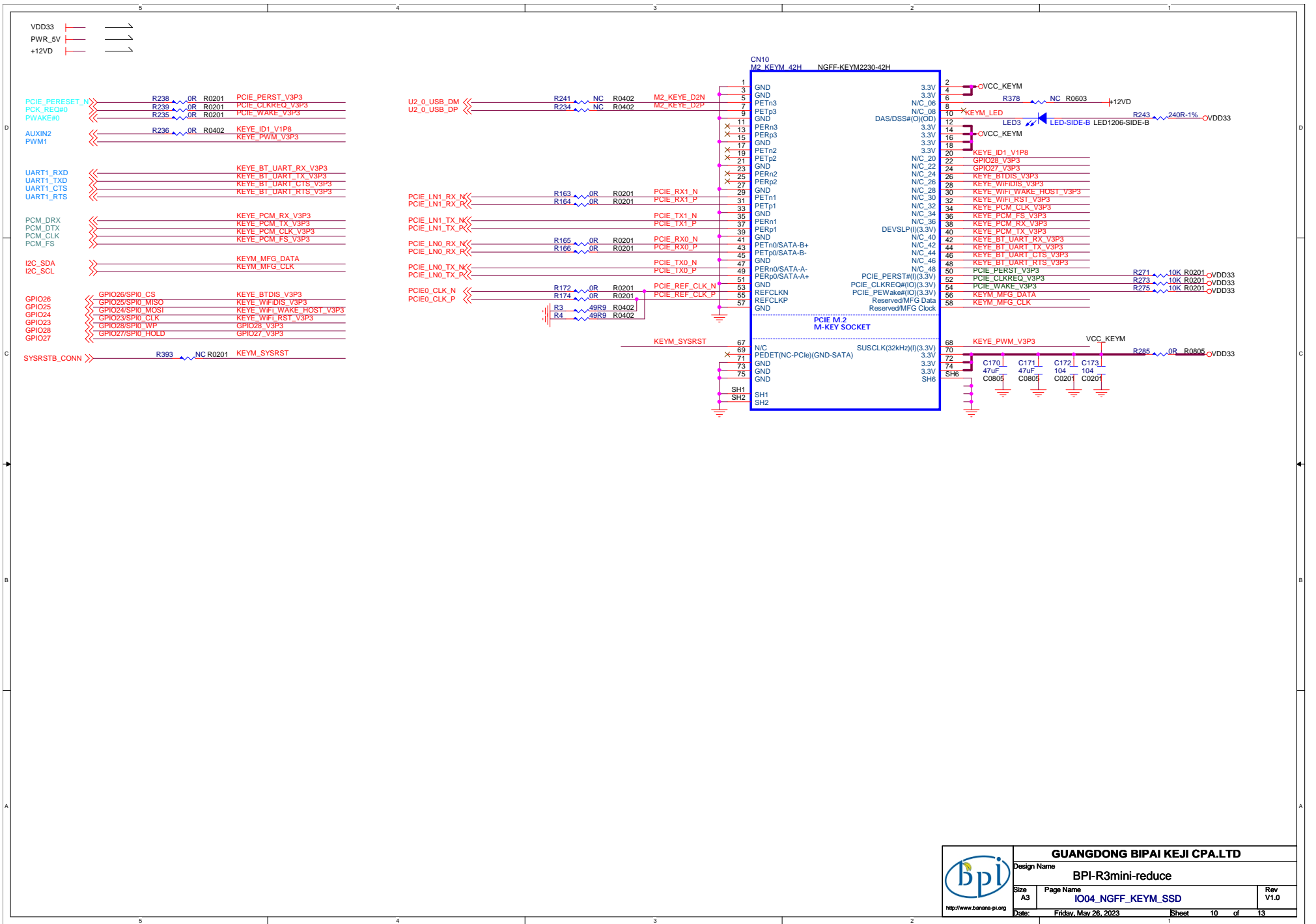

TypeC IN

PD 12V

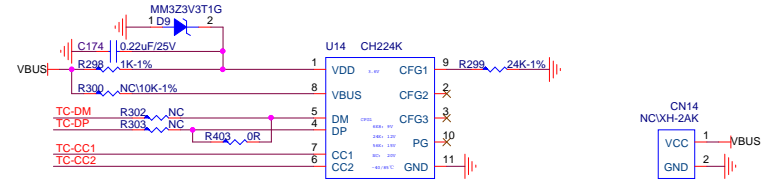
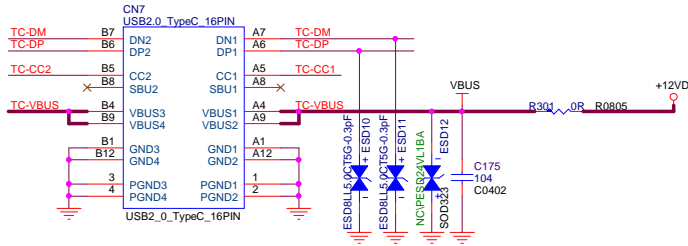

LEDs

FAN

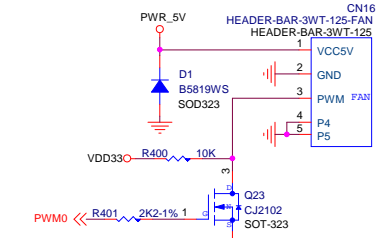
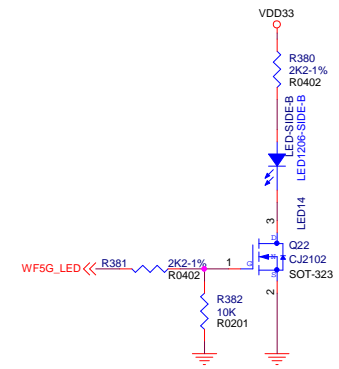
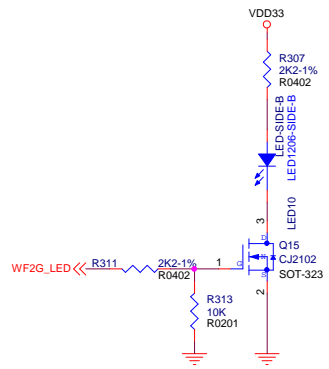
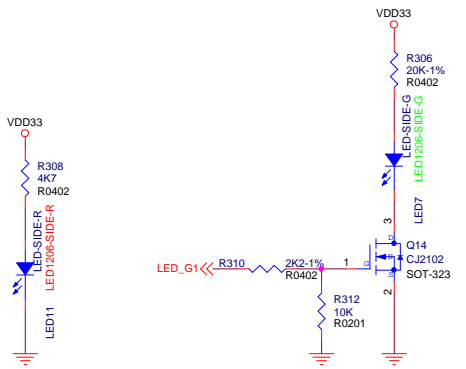

KEYS

Debug

EEPROM

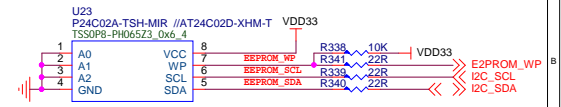
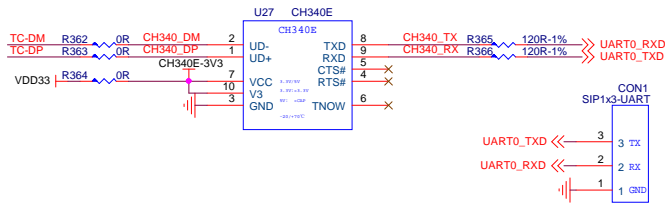
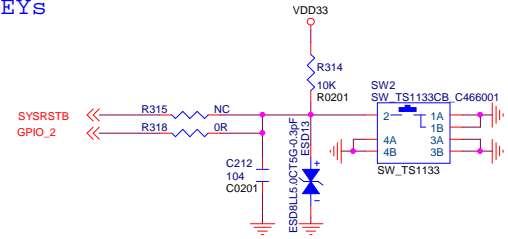

USB 2.0

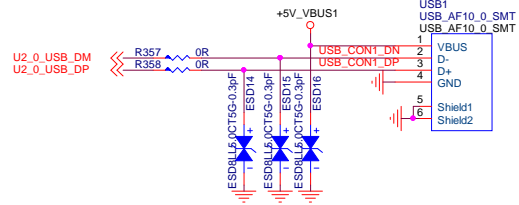
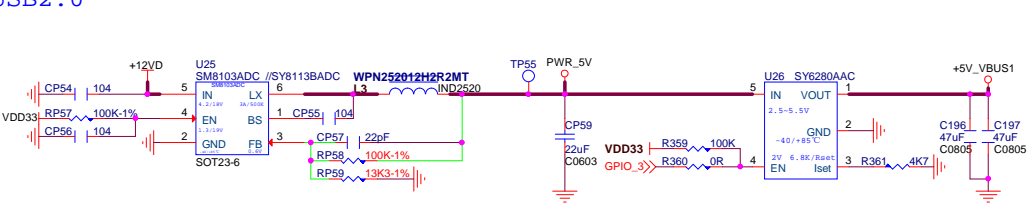

+12VD=5.1V, +5V_VBUS1=4.65V;
+12VD=12V, +5V_VBUS1=5.1V;

		GUANGDONG BIPAI KEJI CPA.LTD	
		Design Name BPI-R3mini-reduce	
Size A3	Page Name I005_DCIN/KEYs/LEDs	Rev V1.0	Date: Thursday, July 27, 2023
http://www.banana-pi.org		Sheet 11	of 13