BBC micro:bit MicroPython Documentation

Release 1.0.1

Multiple authors

Aug 24, 2020

1	Introduction	3
1.1	Hello, World!	3
1.2	Images	4
1.3	Buttons	9
1.4	Input/Output	12
1.5	Music	16
1.6	Random	19
1.7	Movement	21
1.8	Gestures	23
1.9	Direction	24
1.10	Storage	25
1.11	Speech	29
1.12	Network	36
1.13	Radio	42
1.14	Next Steps	45
2	micro:bit Micropython API	47
2.1	The microbit module	47
3	Microbit Module	53
3.1	Functions	53
3.2	Attributes	53
3.3	Classes	59
3.4	Modules	63
4	Audio	75
4.1	Functions	75
4.2	Classes	75
4.3	Using audio	76
4.4	Technical Details	76
4.5	Example	76
5	Bluetooth	79
6	Local Persistent File System	81
7	Machine	83

7.1	Functions	83
7.2	Reading Memory	84
8	MicroPython	85
8.1	Functions	85
9	Music	87
9.1	Musical Notation	88
9.2	Functions	89
10	NeoPixel	93
10.1	Classes	94
10.2	Operations	95
10.3	Using Neopixels	95
10.4	Example	95
11	The os Module	97
11.1	Functions	97
12	Radio	99
12.1	Constants	99
12.2	Functions	100
13	Random Number Generation	103
13.1	Functions	103
14	Speech	105
14.1	Functions	107
14.2	Punctuation	107
14.3	Timbre	107
14.4	Phonemes	108
14.5	Singing	111
14.6	How Does it Work?	112
14.7	Example	112
15	utime	115
15.1	Functions	115
16	Installation	117
16.1	Dependencies	117
16.2	Development Environment	117
16.3	Installation Scenarios	117
16.4	Next steps	118
17	Flashing Firmware	119
17.1	Building firmware	119
17.2	Preparing firmware and a Python program	119
17.3	Flashing to the micro:bit	120
18	Accessing the REPL	121
18.1	Using a serial communication program	121
18.2	Determining the port	121
18.3	Communicating with the micro:bit	122
19	Firmware Hex File	123
19.1	Appended script format	123

19.2	UICR format	124
19.3	Steps to create the firmware.hex file	124
20	Developer FAQ	125
21	Contributing	127
21.1	Checklist	127
	Python Module Index	129
	Index	131

Welcome!

The BBC micro:bit is a small computing device for children. One of the languages it understands is the popular Python programming language. The version of Python that runs on the BBC micro:bit is called MicroPython.

This documentation includes lessons for teachers and API documentation for developers (check out the index on the left). We hope you enjoy developing for the BBC micro:bit using MicroPython.

If you're a new programmer, teacher or unsure where to start, begin with the tutorials.

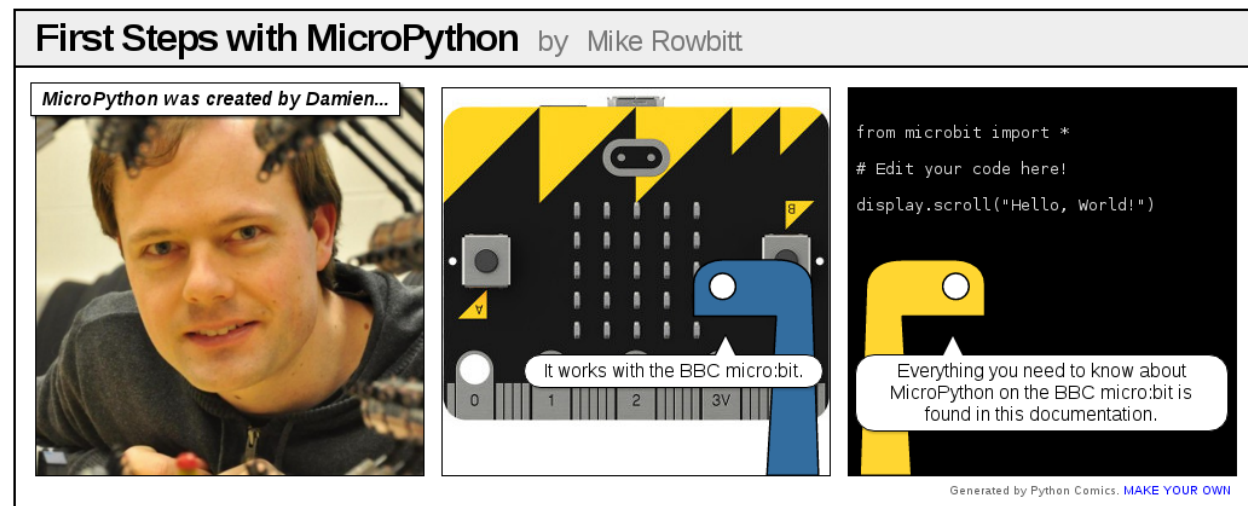

Note: This project is under active development. Please help other developers by adding tips, how-tos, and Q&A to this document. Thanks!

Projects related to MicroPython on the BBC micro:bit include:

- [Mu](#) - a simple code editor for kids, teachers and beginner programmers. Probably the easiest way for people to program MicroPython on the BBC micro:bit.
- [uFlash](#) - a command line tool for flashing raw Python scripts onto a BBC micro:bit.

We suggest you download and use the [mu editor](#) when working through these tutorials. Instructions for downloading and installing Mu are on its website. You may need to install a driver, depending on your platform (instructions are on the website).

Mu works with Windows, OSX and Linux.

Once Mu is installed connect your micro:bit to your computer via a USB lead.

Write your script in the editor window and click the “Flash” button to transfer it to the micro:bit. If it doesn’t work, make sure your micro:bit appears as a USB storage device in your file system explorer.

1.1 Hello, World!

The traditional way to start programming in a new language is to get your computer to say, “Hello, World!”.

This is easy with MicroPython:

```
from microbit import *
display.scroll("Hello, World!")
```

Each line does something special. The first line:

```
from microbit import *
```

... tells MicroPython to get all the stuff it needs to work with the BBC micro:bit. All this stuff is in a module called `microbit` (a module is a library of pre-existing code). When you `import` something you’re telling MicroPython that you want to use it, and `*` is Python’s way to say *everything*. So, `from microbit import *` means, in English, “I want to be able to use everything from the microbit code library”.

The second line:

```
display.scroll("Hello, World!")
```

...tells MicroPython to use the `display` to scroll the string of characters “Hello, World!”. The `display` part of that line is an *object* from the `microbit` module that represents the device’s physical display (we say “object” instead of “thingy”, “whatsit” or “doodah”). We can tell the display to do things with a full-stop `.` followed by what looks like a command (in fact it’s something we call a *method*). In this case we’re using the `scroll` method. Since `scroll` needs to know what characters to scroll across the physical display we specify them between double quotes (`"`) within parenthesis (`(` and `)`). These are called the *arguments*. So, `display.scroll("Hello, World!")` means, in English, “I want you to use the display to scroll the text ‘Hello, World!’”. If a method doesn’t need any arguments we make this clear by using empty parenthesis like this: `()`.

Copy the “Hello, World!” code into your editor and flash it onto the device. Can you work out how to change the message? Can you make it say hello to you? For example, I might make it say “Hello, Nicholas!”. Here’s a clue, you need to change the scroll method’s argument.

Warning: It may not work. :-)

This is where things get fun and MicroPython tries to be helpful. If it encounters an error it will scroll a helpful message on the micro:bit’s display. If it can, it will tell you the line number for where the error can be found.

Python expects you to type **EXACTLY** the right thing. So, for instance, `Microbit`, `microbit` and `microBit` are all different things to Python. If MicroPython complains about a `NameError` it’s probably because you’ve typed something inaccurately. It’s like the difference between referring to “Nicholas” and “Nicolas”. They’re two different people but their names look very similar.

If MicroPython complains about a `SyntaxError` you’ve simply typed code in a way that MicroPython can’t understand. Check you’re not missing any special characters like `"` or `..`. It’s like putting a full stop in the middle of a sentence. It’s hard to understand exactly what you mean.

Your microbit may stop responding: you cannot flash new code to it or enter commands into the REPL. If this happens, try power cycling it. That is, unplug the USB cable (and battery cable if it’s connected), then plug the cable back in again. You may also need to quit and re-start your code editor application.

1.2 Images

MicroPython is about as good at art as you can be if the only thing you have is a 5x5 grid of red LEDs (light emitting diodes - the things that light up on the front of the device). MicroPython gives you quite a lot of control over the display so you can create all sorts of interesting effects.

MicroPython comes with lots of built-in pictures to show on the display. For example, to make the device appear happy you type:

```
from microbit import *
display.show(Image.HAPPY)
```

I suspect you can remember what the first line does. The second line uses the `display` object to show a built-in image. The happy image we want to display is a part of the `Image` object and called `HAPPY`. We tell `show` to use it by putting it between the parenthesis (`(` and `)`).

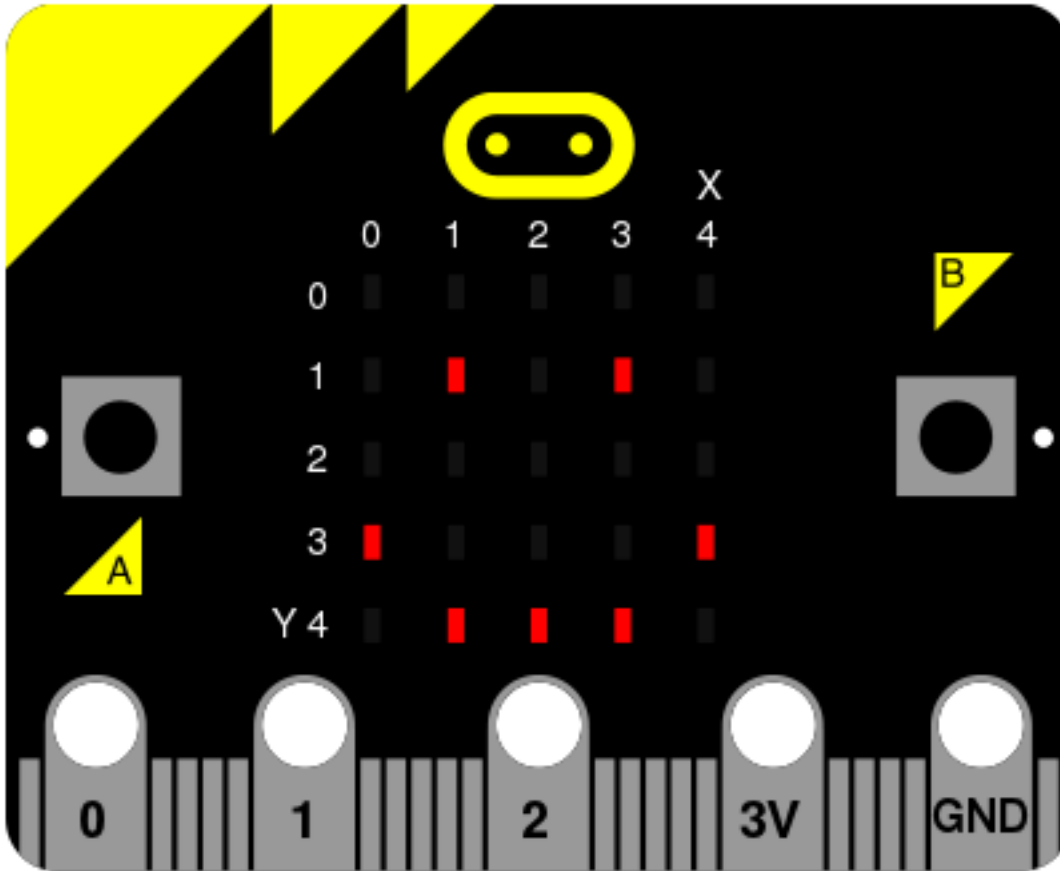

Here's a list of the built-in images:

- `Image.HEART`
- `Image.HEART_SMALL`
- `Image.HAPPY`
- `Image.SMILE`
- `Image.SAD`
- `Image.CONFUSED`
- `Image.ANGRY`
- `Image.ASLEEP`
- `Image.SURPRISED`
- `Image.SILLY`
- `Image.FABULOUS`
- `Image.MEH`
- `Image.YES`
- `Image.NO`
- `Image.CLOCK12`, `Image.CLOCK11`, `Image.CLOCK10`, `Image.CLOCK9`, `Image.CLOCK8`, `Image.CLOCK7`, `Image.CLOCK6`, `Image.CLOCK5`, `Image.CLOCK4`, `Image.CLOCK3`, `Image.CLOCK2`,

`Image.CLOCK1`

- `Image.ARROW_N`, `Image.ARROW_NE`, `Image.ARROW_E`, `Image.ARROW_SE`, `Image.ARROW_S`, `Image.ARROW_SW`, `Image.ARROW_W`, `Image.ARROW_NW`
- `Image.TRIANGLE`
- `Image.TRIANGLE_LEFT`
- `Image.CHESSBOARD`
- `Image.DIAMOND`
- `Image.DIAMOND_SMALL`
- `Image.SQUARE`
- `Image.SQUARE_SMALL`
- `Image.RABBIT`
- `Image.COW`
- `Image.MUSIC_CROTCHET`
- `Image.MUSIC_QUAVER`
- `Image.MUSIC_QUAVERS`
- `Image.PITCHFORK`
- `Image.XMAS`
- `Image.PACMAN`
- `Image.TARGET`
- `Image.TSHIRT`
- `Image.ROLLERSKATE`
- `Image.DUCK`
- `Image.HOUSE`
- `Image.TORTOISE`
- `Image.BUTTERFLY`
- `Image.STICKFIGURE`
- `Image.GHOST`
- `Image.SWORD`
- `Image.GIRAFFE`
- `Image.SKULL`
- `Image.UMBRELLA`
- `Image.SNAKE`

There's quite a lot! Why not modify the code that makes the micro:bit look happy to see what some of the other built-in images look like? (Just replace `Image.HAPPY` with one of the built-in images listed above.)

1.2.1 DIY Images

Of course, you want to make your own image to display on the micro:bit, right?

That's easy.

Each LED pixel on the physical display can be set to one of ten values. If a pixel is set to 0 (zero) then it's off. It literally has zero brightness. However, if it is set to 9 then it is at its brightest level. The values 1 to 8 represent the brightness levels between off (0) and full on (9).

Armed with this information, it's possible to create a new image like this:

```
from microbit import *

boat = Image("05050:"
             "05050:"
             "05050:"
             "99999:"
             "09990")

display.show(boat)
```

(When run, the device should display an old-fashioned "Blue Peter" sailing ship with the masts dimmer than the boat's hull.)

Have you figured out how to draw a picture? Have you noticed that each line of the physical display is represented by a line of numbers ending in : and enclosed between " double quotes? Each number specifies a brightness. There are five lines of five numbers so it's possible to specify the individual brightness for each of the five pixels on each of the five lines on the physical display. That's how to create a new image.

Simple!

In fact, you don't need to write this over several lines. If you think you can keep track of each line, you can rewrite it like this:

```
boat = Image("05050:05050:05050:99999:09990")
```

1.2.2 Animation

Static images are fun, but it's even more fun to make them move. This is also amazingly simple to do with MicroPython ~ just use a list of images!

Here is a shopping list:

```
Eggs
Bacon
Tomatoes
```

Here's how you'd represent this list in Python:

```
shopping = ["Eggs", "Bacon", "Tomatoes"]
```

I've simply created a list called `shopping` and it contains three items. Python knows it's a list because it's enclosed in square brackets (`[` and `]`). Items in the list are separated by a comma (`,`) and in this instance the items are three strings of characters: `"Eggs"`, `"Bacon"` and `"Tomatoes"`. We know they are strings of characters because they're enclosed in quotation marks `"`.

You can store anything in a list with Python. Here's a list of numbers:

```
primes = [2, 3, 5, 7, 11, 13, 17, 19]
```

Note: Numbers don't need to be quoted since they represent a value (rather than a string of characters). It's the difference between 2 (the numeric value 2) and "2" (the character/digit representing the number 2). Don't worry if this doesn't make sense right now. You'll soon get used to it.

It's even possible to store different sorts of things in the same list:

```
mixed_up_list = ["hello!", 1.234, Image.HAPPY]
```

Notice that last item? It was an image!

We can tell MicroPython to animate a list of images. Luckily we have a couple of lists of images already built in. They're called `Image.ALL_CLOCKS` and `Image.ALL_ARROWS`:

```
from microbit import *  
  
display.show(Image.ALL_CLOCKS, loop=True, delay=100)
```

As with a single image, we use `display.show` to show it on the device's display. However, we tell MicroPython to use `Image.ALL_CLOCKS` and it understands that it needs to show each image in the list, one after the other. We also tell MicroPython to keep looping over the list of images (so the animation lasts forever) by saying `loop=True`. Furthermore, we tell it that we want the delay between each image to be only 100 milliseconds (a tenth of a second) with the argument `delay=100`.

Can you work out how to animate over the `Image.ALL_ARROWS` list? How do you avoid looping forever (hint: the opposite of `True` is `False` although the default value for `loop` is `False`)? Can you change the speed of the animation?

Finally, here's how to create your own animation. In my example I'm going to make my boat sink into the bottom of the display:

```
from microbit import *  
  
boat1 = Image("05050:"  
              "05050:"  
              "05050:"  
              "99999:"  
              "09990")  
  
boat2 = Image("00000:"  
              "05050:"  
              "05050:"  
              "05050:"  
              "99999")  
  
boat3 = Image("00000:"  
              "00000:"  
              "05050:"  
              "05050:"  
              "05050")  
  
boat4 = Image("00000:"  
              "00000:"  
              "00000:"  
              "05050:")
```

(continues on next page)

(continued from previous page)

```

        "05050")

boat5 = Image("00000:"
             "00000:"
             "00000:"
             "00000:"
             "05050")

boat6 = Image("00000:"
             "00000:"
             "00000:"
             "00000:"
             "00000")

all_boats = [boat1, boat2, boat3, boat4, boat5, boat6]
display.show(all_boats, delay=200)

```

Here's how the code works:

- I create six `boat` images in exactly the same way I described above.
- Then, I put them all into a list that I call `all_boats`.
- Finally, I ask `display.show` to animate the list with a delay of 200 milliseconds.
- Since I've not set `loop=True` the boat will only sink once (thus making my animation scientifically accurate). :-)

What would you animate? Can you animate special effects? How would you make an image fade out and then fade in again?

1.3 Buttons

So far we have created code that makes the device do something. This is called *output*. However, we also need the device to react to things. Such things are called *inputs*.

It's easy to remember: output is what the device puts out to the world whereas input is what goes into the device for it to process.

The most obvious means of input on the micro:bit are its two buttons, labelled A and B. Somehow, we need MicroPython to react to button presses.

This is remarkably simple:

```

from microbit import *

sleep(10000)
display.scroll(str(button_a.get_presses()))

```

All this script does is sleep for ten thousand milliseconds (i.e. 10 seconds) and then scrolls the number of times you pressed button A. That's it!

While it's a pretty useless script, it introduces a couple of interesting new ideas:

1. The `sleep` function will make the micro:bit sleep for a certain number of milliseconds. If you want a pause in your program, this is how to do it. A *function* is just like a *method*, but it isn't attached by a dot to an *object*.

2. There is an object called `button_a` and it allows you to get the number of times it has been pressed with the `get_presses` *method*.

Since `get_presses` gives a numeric value and `display.scroll` only displays characters, we need to convert the numeric value into a string of characters. We do this with the `str` function (short for “string” ~ it converts things into strings of characters).

The third line is a bit like an onion. If the parenthesis are the onion skins then you’ll notice that `display.scroll` contains `str` that itself contains `button_a.get_presses`. Python attempts to work out the inner-most answer first before starting on the next layer out. This is called *nesting* - the coding equivalent of a Russian Matrioshka doll.



Let’s pretend you’ve pressed the button 10 times. Here’s how Python works out what’s happening on the third line:

Python sees the complete line and gets the value of `get_presses`:

```
display.scroll(str(button_a.get_presses()))
```

Now that Python knows how many button presses there have been, it converts the numeric value into a string of characters:

```
display.scroll(str(10))
```

Finally, Python knows what to scroll across the display:

```
display.scroll("10")
```

While this might seem like a lot of work, MicroPython makes this happen extraordinarily fast.

1.3.1 Event Loops

Often you need your program to hang around waiting for something to happen. To do this you make it loop around a piece of code that defines how to react to certain expected events such as a button press.

To make loops in Python you use the `while` keyword. It checks if something is `True`. If it is, it runs a *block of code* called the *body* of the loop. If it isn’t, it breaks out of the loop (ignoring the body) and the rest of the program can continue.

Python makes it easy to define blocks of code. Say I have a to-do list written on a piece of paper. It probably looks something like this:

```
Shopping
Fix broken gutter
Mow the lawn
```

If I wanted to break down my to-do list a bit further, I might write something like this:

```
Shopping:
    Eggs
    Bacon
    Tomatoes
Fix broken gutter:
    Borrow ladder from next door
    Find hammer and nails
    Return ladder
Mow the lawn:
    Check lawn around pond for frogs
    Check mower fuel level
```

It's obvious that the main tasks are broken down into sub-tasks that are *indented* underneath the main task to which they are related. So Eggs, Bacon and Tomatoes are obviously related to Shopping. By indenting things we make it easy to see, at a glance, how the tasks relate to each other.

This is called *nesting*. We use nesting to define blocks of code like this:

```
from microbit import *

while running_time() < 10000:
    display.show(Image.ASLEEP)

display.show(Image.SURPRISED)
```

The `running_time` function returns the number of milliseconds since the device started.

The `while running_time() < 10000:` line checks if the running time is less than 10000 milliseconds (i.e. 10 seconds). If it is, *and this is where we can see scoping in action*, then it'll display `Image.ASLEEP`. Notice how this is indented underneath the `while` statement *just like in our to-do list*.

Obviously, if the running time is equal to or greater than 10000 milliseconds then the display will show `Image.SURPRISED`. Why? Because the `while` condition will be `False` (`running_time` is no longer `< 10000`). In that case the loop is finished and the program will continue after the `while` loop's block of code. It'll look like your device is asleep for 10 seconds before waking up with a surprised look on its face.

Try it!

1.3.2 Handling an Event

If we want MicroPython to react to button press events we should put it into an infinite loop and check if the button `is_pressed`.

An infinite loop is easy:

```
while True:
    # Do stuff
```

(Remember, while checks if something is `True` to work out if it should run its block of code. Since `True` is obviously `True` for all time, you get an infinite loop!)

Let's make a very simple cyber-pet. It's always sad unless you're pressing button A. If you press button B it dies. (I realise this isn't a very pleasant game, so perhaps you can figure out how to improve it.):

```
from microbit import *

while True:
    if button_a.is_pressed():
        display.show(Image.HAPPY)
    elif button_b.is_pressed():
        break
    else:
        display.show(Image.SAD)

display.clear()
```

Can you see how we check what buttons are pressed? We used `if`, `elif` (short for “else if”) and `else`. These are called *conditionals* and work like this:

```
if something is True:
    # do one thing
elif some other thing is True:
    # do another thing
else:
    # do yet another thing.
```

This is remarkably similar to English!

The `is_pressed` method only produces two results: `True` or `False`. If you're pressing the button it returns `True`, otherwise it returns `False`. The code above is saying, in English, “for ever and ever, if button A is pressed then show a happy face, else if button B is pressed break out of the loop, otherwise display a sad face.” We break out of the loop (stop the program running for ever and ever) with the `break` statement.

At the very end, when the cyber-pet is dead, we `clear` the display.

Can you think of ways to make this game less tragic? How would you check if *both* buttons are pressed? (Hint: Python has `and`, `or` and `not` logical operators to help check multiple truth statements (things that produce either `True` or `False` results).

1.4 Input/Output

There are strips of metal along the bottom edge of the BBC micro:bit that make it look as if the device has teeth. These are the input/output pins (or I/O pins for short).

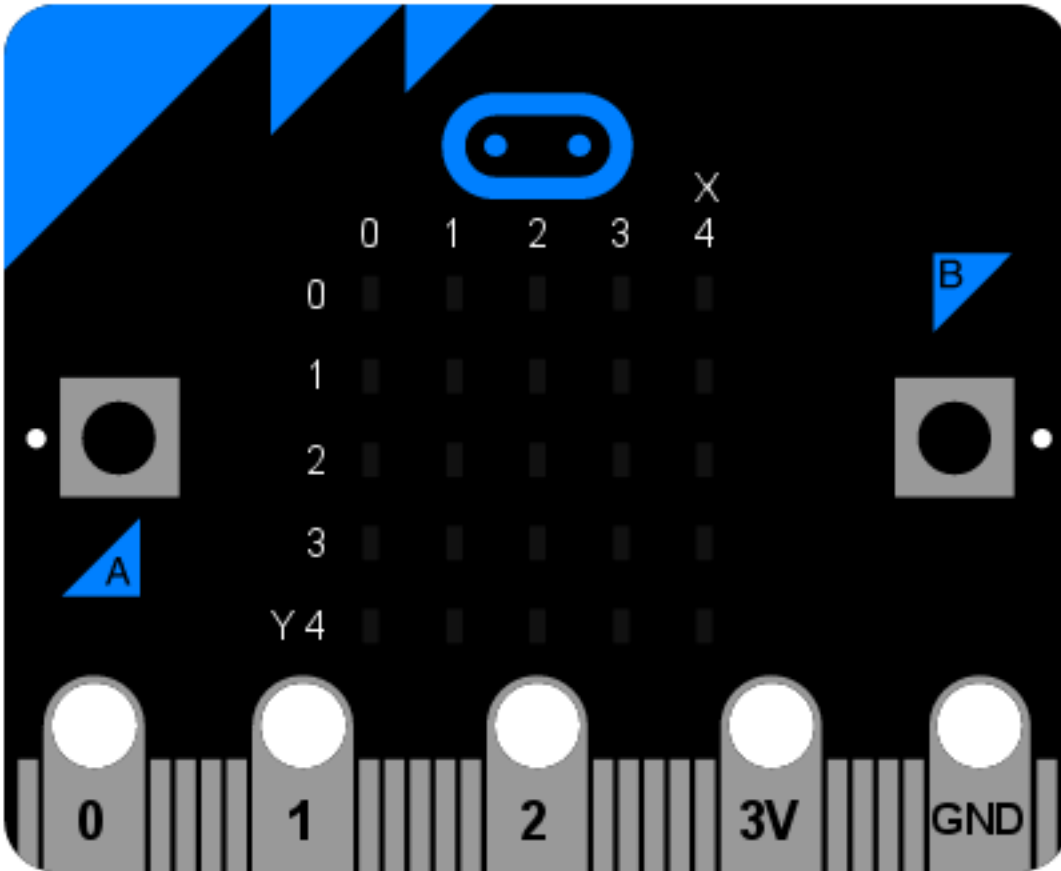

Some of the pins are bigger than others so it's possible to attach crocodile clips to them. These are the ones labelled 0, 1, 2, 3V and GND (computers always start counting from zero). If you attach an edge connector board to the device it's possible to plug in wires connected to the other (smaller) pins.

Each pin on the BBC micro:bit is represented by an *object* called `pinN` where `N` is the pin number. So, for example, to do things with the pin labelled with a 0 (zero), use the object called `pin0`.

Simple!

These objects have various *methods* associated with them depending upon what the specific pin is capable of.

1.4.1 Ticklish Python

The simplest example of input via the pins is a check to see if they are touched. So, you can tickle your device to make it laugh like this:

```
from microbit import *

while True:
    if pin0.is_touched():
        display.show(Image.HAPPY)
    else:
        display.show(Image.SAD)
```

With one hand, hold your device by the GND pin. Then, with your other hand, touch (or tickle) the 0 (zero) pin. You should see the display change from grumpy to happy!

This is a form of very basic input measurement. However, the fun really starts when you plug in circuits and other devices via the pins.

1.4.2 Bleeps and Bloops

The simplest thing we can attach to the device is a Piezo buzzer. We're going to use it for output.



These small devices play a high-pitched bleep when connected to a circuit. To attach one to your BBC micro:bit you should attach crocodile clips to pin 0 and GND (as shown below).

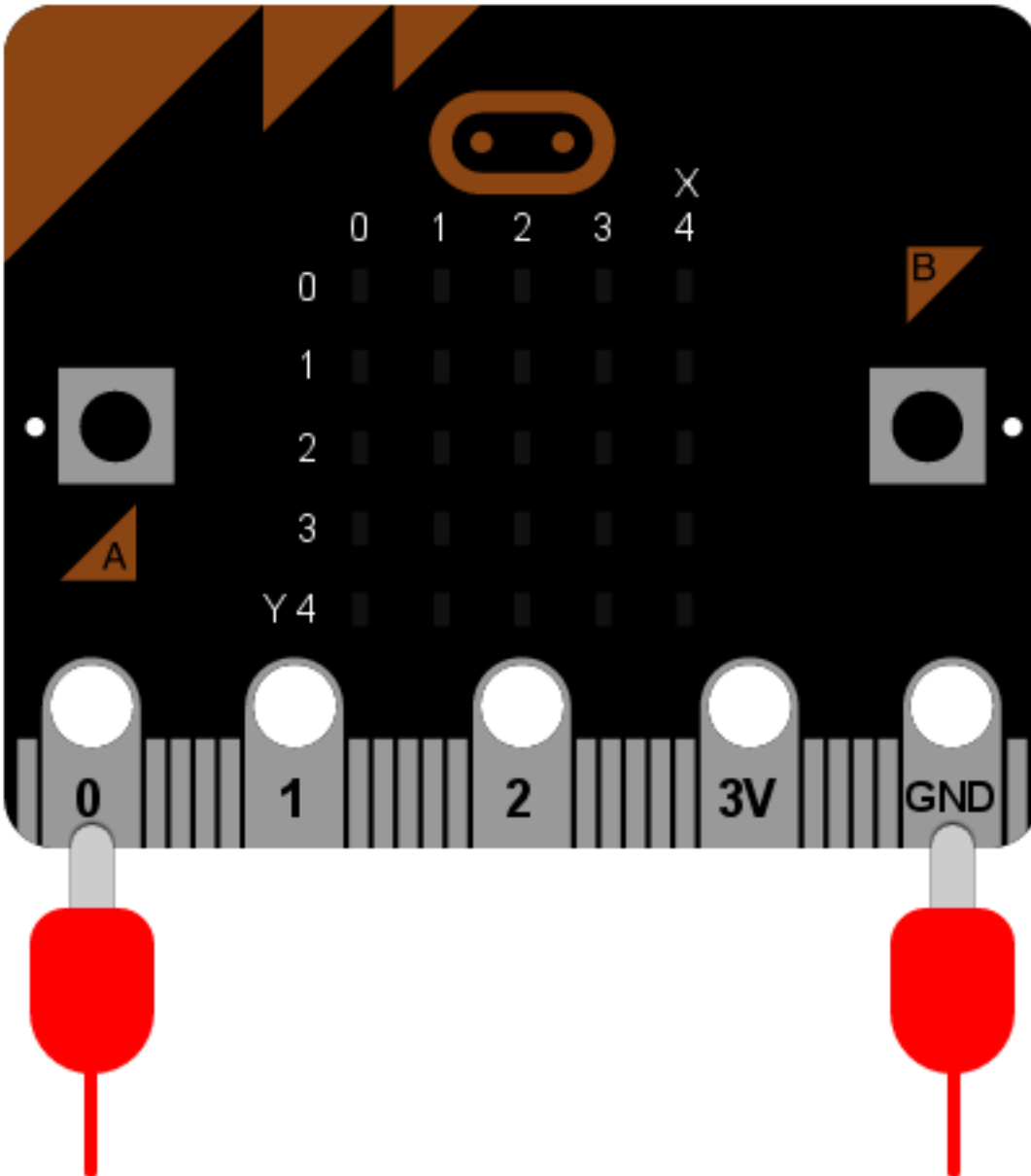

The wire from pin 0 should be attached to the positive connector on the buzzer and the wire from GND to the negative connector.

The following program will cause the buzzer to make a sound:

```
from microbit import *  
pin0.write_digital(1)
```

This is fun for about 5 seconds and then you'll want to make the horrible squeaking stop. Let's improve our example and make the device bleep:

```
from microbit import *  
while True:
```

(continues on next page)

(continued from previous page)

```
pin0.write_digital(1)
sleep(20)
pin0.write_digital(0)
sleep(480)
```

Can you work out how this script works? Remember that 1 is “on” and 0 is “off” in the digital world.

The device is put into an infinite loop and immediately switches pin 0 on. This causes the buzzer to emit a beep. While the buzzer is beeping, the device sleeps for twenty milliseconds and then switches pin 0 off. This gives the effect of a short bleep. Finally, the device sleeps for 480 milliseconds before looping back and starting all over again. This means you’ll get two bleeps per second (one every 500 milliseconds).

We’ve made a very simple metronome!

1.5 Music

MicroPython on the BBC micro:bit comes with a powerful music and sound module. It’s very easy to generate bleeps and bloops from the device *if you attach a speaker*. Use crocodile clips to attach pin 0 and GND to the positive and negative inputs on the speaker - it doesn’t matter which way round they are connected to the speaker.

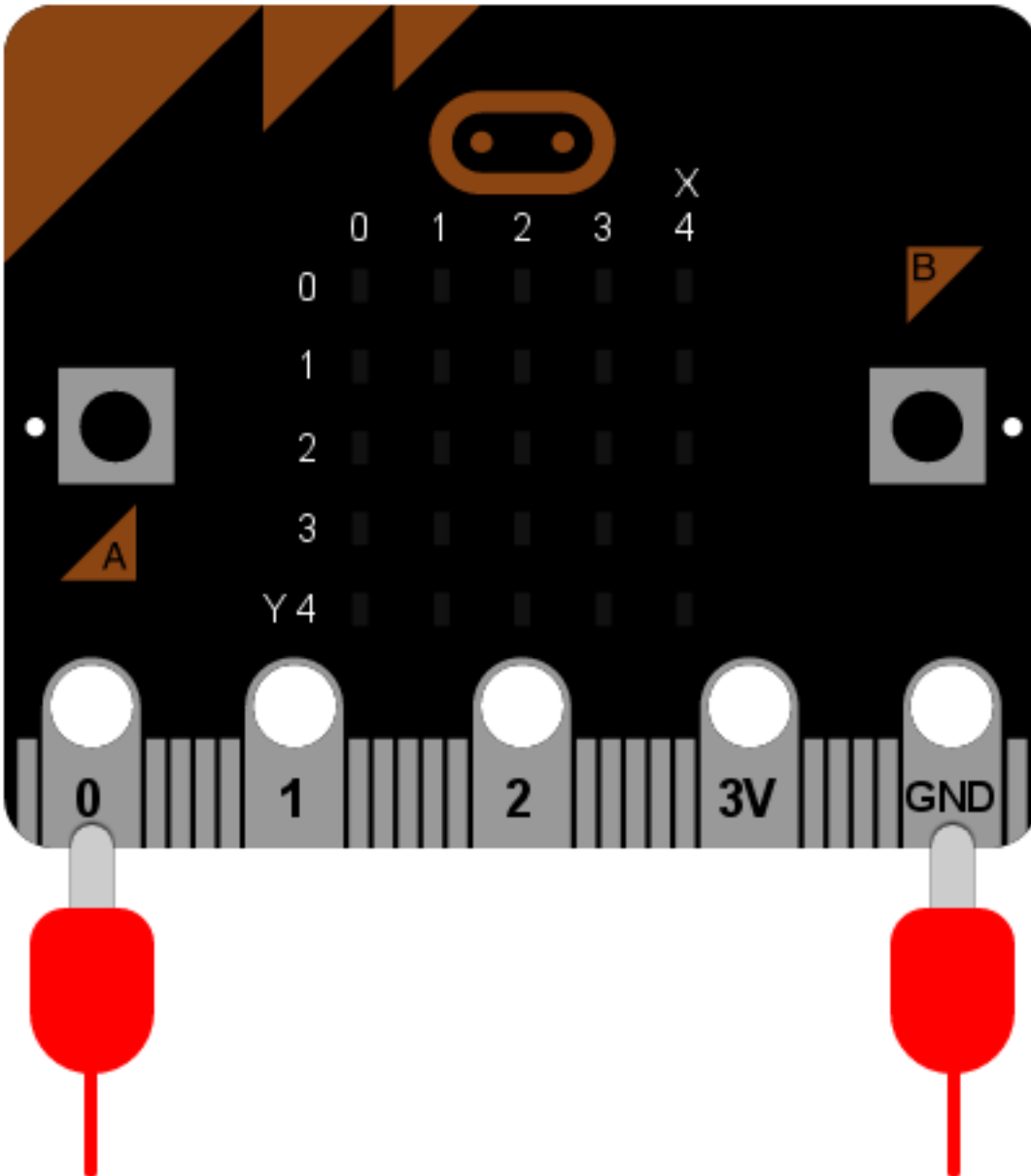

Note: Do not attempt this with a Piezo buzzer - such buzzers are only able to play a single tone.

Let's play some music:

```
import music
music.play(music.NYAN)
```

Notice that we import the `music` module. It contains methods used to make and control sound.

MicroPython has quite a lot of built-in melodies. Here's a complete list:

- `music.DADADADUM`
- `music.ENTERTAINER`

- `music.PRELUDE`
- `music.ODE`
- `music.NYAN`
- `music.RINGTONE`
- `music.FUNK`
- `music.BLUES`
- `music.BIRTHDAY`
- `music.WEDDING`
- `music.FUNERAL`
- `music.PUNCHLINE`
- `music.PYTHON`
- `music.BADDY`
- `music.CHASE`
- `music.BA_DING`
- `music.WAWAWAWAA`
- `music.JUMP_UP`
- `music.JUMP_DOWN`
- `music.POWER_UP`
- `music.POWER_DOWN`

Take the example code and change the melody. Which one is your favourite? How would you use such tunes as signals or cues?

1.5.1 Wolfgang Amadeus Microbit

Creating your own tunes is easy!

Each note has a name (like C# or F), an octave (telling MicroPython how high or low the note should be played) and a duration (how long it lasts through time). Octaves are indicated by a number ~ 0 is the lowest octave, 4 contains middle C and 8 is about as high as you'll ever need unless you're making music for dogs. Durations are also expressed as numbers. The higher the value of the duration the longer it will last. Such values are related to each other - for instance, a duration of 4 will last twice as long as a duration 2 (and so on). If you use the note name R then MicroPython will play a rest (i.e. silence) for the specified duration.

Each note is expressed as a string of characters like this:

```
NOTE[octave][:duration]
```

For example, "A1 : 4 " refers to the note named A in octave number 1 to be played for a duration of 4.

Make a list of notes to create a melody (it's equivalent to creating an animation with a list of images). For example, here's how to make MicroPython play opening of "Frere Jaques":

```
import music

tune = ["C4:4", "D4:4", "E4:4", "C4:4", "C4:4", "D4:4", "E4:4", "C4:4",
        "E4:4", "F4:4", "G4:8", "E4:4", "F4:4", "G4:8"]
music.play(tune)
```

Note: MicroPython helps you to simplify such melodies. It'll remember the octave and duration values until you next change them. As a result, the example above can be re-written as:

```
import music

tune = ["C4:4", "D", "E", "C", "C", "D", "E", "C", "E", "F", "G:8",
        "E:4", "F", "G:8"]
music.play(tune)
```

Notice how the octave and duration values only change when they have to. It's a lot less typing and simpler to read.

1.5.2 Sound Effects

MicroPython lets you make tones that are not musical notes. For example, here's how to create a Police siren effect:

```
import music

while True:
    for freq in range(880, 1760, 16):
        music.pitch(freq, 6)
    for freq in range(1760, 880, -16):
        music.pitch(freq, 6)
```

Notice how the `music.pitch` *method* is used in this instance. It expects a frequency. For example, the frequency of 440 is the same as a concert A used to tune a symphony orchestra.

In the example above the `range` function is used to generate ranges of numeric values. These numbers are used to define the pitch of the tone. The three arguments for the `range` function are the start value, end value and step size. Therefore, the first use of `range` is saying, in English, "create a range of numbers between 880 and 1760 in steps of 16". The second use of `range` is saying, "create a range of values between 1760 and 880 in steps of -16". This is how we get a range of frequencies that go up and down in pitch like a siren.

Because the siren should last forever it's wrapped in an infinite `while` loop.

Importantly, we have introduced a new sort of a loop inside the `while` loop: the `for` loop. In English it's like saying, "for each item in some collection, do some activity with it". Specifically in the example above, it's saying, "for each frequency in the specified range of frequencies, play the pitch of that frequency for 6 milliseconds". Notice how the thing to do for each item in a `for` loop is indented (as discussed earlier) so Python knows exactly which code to run to handle the individual items.

1.6 Random

Sometimes you want to leave things to chance, or mix it up a little: you want the device to act randomly.

MicroPython comes with a `random` module to make it easy to introduce chance and a little chaos into your code. For example, here's how to scroll a random name across the display:

```
from microbit import *
import random

names = ["Mary", "Yolanda", "Damien", "Alia", "Kushal", "Mei Xiu", "Zoltan" ]

display.scroll(random.choice(names))
```

The list (`names`) contains seven names defined as strings of characters. The final line is *nested* (the “onion” effect introduced earlier): the `random.choice` method takes the `names` list as an argument and returns an item chosen at random. This item (the randomly chosen name) is the argument for `display.scroll`.

Can you modify the list to include your own set of names?

1.6.1 Random Numbers

Random numbers are very useful. They’re common in games. Why else do we have dice?

MicroPython comes with several useful random number methods. Here’s how to make a simple dice:

```
from microbit import *
import random

display.show(str(random.randint(1, 6)))
```

Every time the device is reset it displays a number between 1 and 6. You’re starting to get familiar with *nesting*, so it’s important to note that `random.randint` returns a whole number between the two arguments, inclusive (a whole number is also called an integer - hence the name of the method). Notice that because `display.show` expects a character then we use the `str` function to turn the numeric value into a character (we turn, for example, 6 into “6”).

If you know you’ll always want a number between 0 and N then use the `random.randrange` method. If you give it a single argument it’ll return random integers up to, but not including, the value of the argument N (this is different to the behaviour of `random.randint`).

Sometimes you need numbers with a decimal point in them. These are called *floating point* numbers and it’s possible to generate such a number with the `random.random` method. This only returns values between 0.0 and 1.0 inclusive. If you need larger random floating point numbers add the results of `random.randrange` and `random.random` like this:

```
from microbit import *
import random

answer = random.randrange(100) + random.random()
display.scroll(str(answer))
```

1.6.2 Seeds of Chaos

The random number generators used by computers are not truly random. They just give random like results given a starting *seed* value. The seed is often generated from random-ish values such as the current time and/or readings from sensors such as the thermometers built into chips.

Sometimes you want to have repeatable random-ish behaviour: a source of randomness that is reproducible. It’s like saying that you need the same five random values each time you throw a dice.

This is easy to achieve by setting the *seed* value. Given a known seed the random number generator will create the same set of random numbers. The seed is set with `random.seed` and any whole number (integer). This version of the dice program always produces the same results:

```

from microbit import *
import random

random.seed(1337)
while True:
    if button_a.was_pressed():
        display.show(str(random.randint(1, 6)))

```

Can you work out why this program needs us to press button A instead of reset the device as in the first dice example..?

1.7 Movement

Your BBC micro:bit comes with an accelerometer. It measures movement along three axes:

- X - tilting from left to right.
- Y - tilting forwards and backwards.
- Z - moving up and down.

There is a method for each axis that returns a positive or negative number indicating a measurement in milli-g's. When the reading is 0 you are "level" along that particular axis.

For example, here's a very simple spirit-level that uses `get_x` to measure how level the device is along the X axis:

```

from microbit import *

while True:
    reading = accelerometer.get_x()
    if reading > 20:
        display.show("R")
    elif reading < -20:
        display.show("L")
    else:
        display.show("-")

```

If you hold the device flat it should display `-`; however, rotate it left or right and it'll show `L` and `R` respectively.

We want the device to constantly react to change, so we use an infinite `while` loop. The first thing to happen *within the body of the loop* is a measurement along the X axis which is called `reading`. Because the accelerometer is *so* sensitive I've made level `+/-20` in range. It's why the `if` and `elif` conditionals check for `> 20` and `< -20`. The `else` statement means that if the `reading` is between `-20` and `20` then we consider it level. For each of these conditions we use the `display` to show the appropriate character.

There is also a `get_y` method for the Y axis and a `get_z` method for the Z axis.

If you've ever wondered how a mobile phone knows which up to show the images on its screen, it's because it uses an accelerometer in exactly the same way as the program above. Game controllers also contain accelerometers to help you steer and move around in games.

1.7.1 Musical Mayhem

One of the most wonderful aspects of MicroPython on the BBC micro:bit is how it lets you easily link different capabilities of the device together. For example, let's turn it into a musical instrument (of sorts).

Connect a speaker as you did in the music tutorial. Use crocodile clips to attach pin 0 and GND to the positive and negative inputs on the speaker - it doesn't matter which way round they are connected to the speaker.

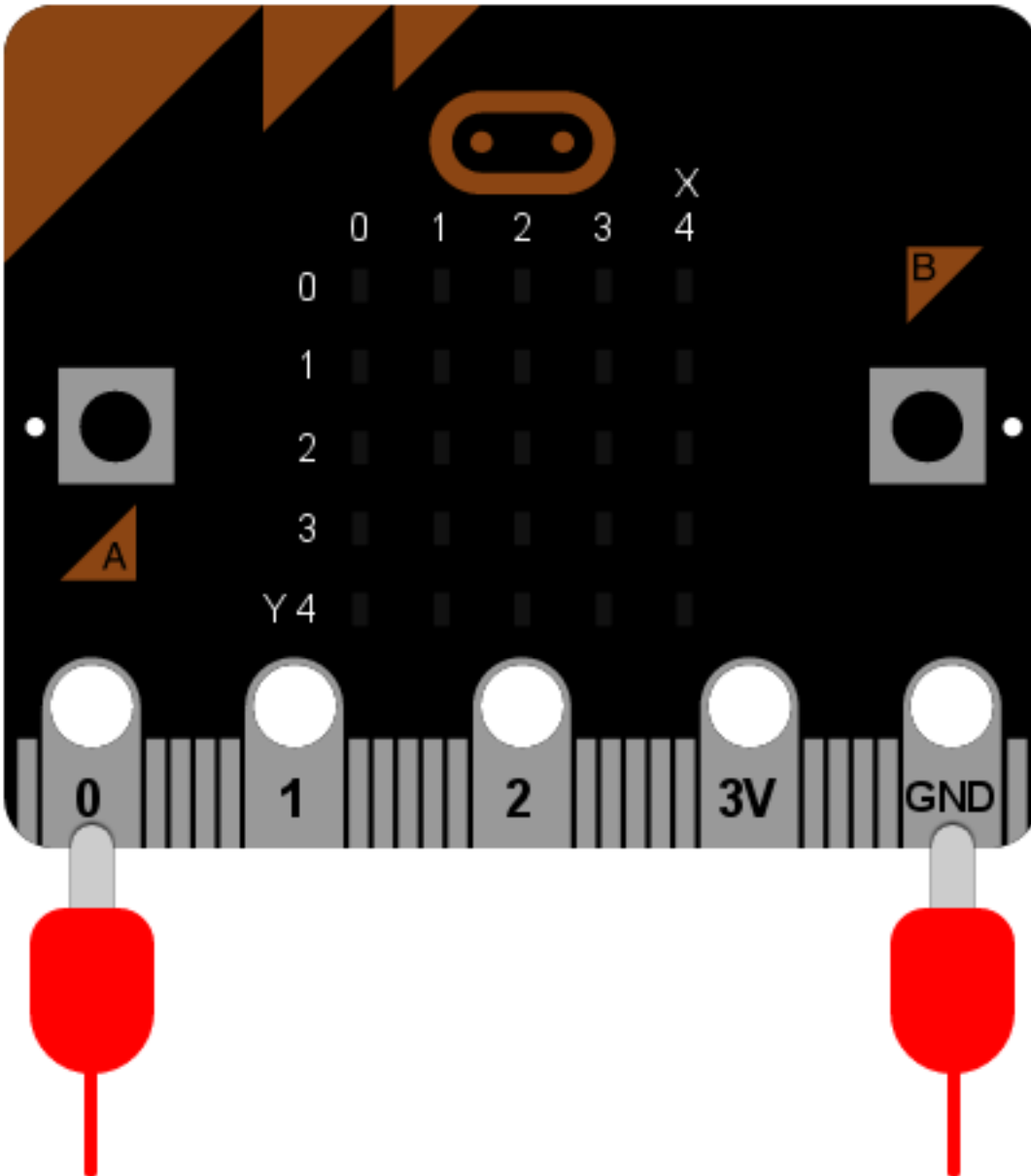

What happens if we take the readings from the accelerometer and play them as pitches? Let's find out:

```
from microbit import *
import music

while True:
    music.pitch(accelerometer.get_y(), 10)
```

The key line is at the end and remarkably simple. We *nest* the reading from the Y axis as the frequency to feed into the `music.pitch` method. We only let it play for 10 milliseconds because we want the tone to change quickly as the device is tipped. Because the device is in an infinite `while` loop it is constantly reacting to changes in the Y axis measurement.

That's it!

Tip the device forwards and backwards. If the reading along the Y axis is positive it'll change the pitch of the tone

played by the micro:bit.

Imagine a whole symphony orchestra of these devices. Can you play a tune? How would you improve the program to make the micro:bit sound more musical?

1.8 Gestures

The really interesting side-effect of having an accelerometer is gesture detection. If you move your BBC micro:bit in a certain way (as a gesture) then MicroPython is able to detect this.

MicroPython is able to recognise the following gestures: up, down, left, right, face up, face down, freefall, 3g, 6g, 8g, shake. Gestures are always represented as strings. While most of the names should be obvious, the 3g, 6g and 8g gestures apply when the device encounters these levels of g-force (like when an astronaut is launched into space).

To get the current gesture use the `accelerometer.current_gesture` method. Its result is going to be one of the named gestures listed above. For example, this program will only make your device happy if it is face up:

```
from microbit import *

while True:
    gesture = accelerometer.current_gesture()
    if gesture == "face up":
        display.show(Image.HAPPY)
    else:
        display.show(Image.ANGRY)
```

Once again, because we want the device to react to changing circumstances we use a `while` loop. Within the *scope* of the loop the current gesture is read and put into `gesture`. The `if` conditional checks if `gesture` is equal to "face up" (Python uses `==` to test for equality, a single equals sign `=` is used for assignment - just like how we assign the gesture reading to the `gesture` object). If the gesture is equal to "face up" then use the display to show a happy face. Otherwise, the device is made to look angry!

1.8.1 Magic-8

A Magic-8 ball is a toy first invented in the 1950s. The idea is to ask it a yes/no question, shake it and wait for it to reveal the truth. It's rather easy to turn into a program:

```
from microbit import *
import random

answers = [
    "It is certain",
    "It is decidedly so",
    "Without a doubt",
    "Yes, definitely",
    "You may rely on it",
    "As I see it, yes",
    "Most likely",
    "Outlook good",
    "Yes",
    "Signs point to yes",
    "Reply hazy try again",
    "Ask again later",
    "Better not tell you now",
```

(continues on next page)

(continued from previous page)

```
"Cannot predict now",
"Concentrate and ask again",
"Don't count on it",
"My reply is no",
"My sources say no",
"Outlook not so good",
"Very doubtful",
]

while True:
    display.show("8")
    if accelerometer.was_gesture("shake"):
        display.clear()
        sleep(1000)
        display.scroll(random.choice(answers))
```

Most of the program is a list called `answers`. The actual game is in the `while` loop at the end.

The default state of the game is to show the character "8". However, the program needs to detect if it has been shaken. The `was_gesture` method uses its argument (in this case, the string "shake" because we want to detect a shake) to return a `True` / `False` response. If the device was shaken the `if` conditional drops into its block of code where it clears the screen, waits for a second (so the device appears to be thinking about your question) and displays a randomly chosen answer.

Why not ask it if this is the greatest program ever written? What could you do to “cheat” and make the answer always positive or negative? (Hint: use the buttons.)

1.9 Direction

There is a compass on the BBC micro:bit. If you ever make a weather station use the device to work out the wind direction.

1.9.1 Compass

It can also tell you the direction of North like this:

```
from microbit import *

compass.calibrate()

while True:
    needle = ((15 - compass.heading()) // 30) % 12
    display.show(Image.ALL_CLOCKS[needle])
```

Note: You must calibrate the compass before taking readings. Failure to do so will produce garbage results. The `calibrate` method runs a fun little game to help the device work out where it is in relation to the Earth’s magnetic field.

To calibrate the compass, tilt the micro:bit around until a circle of pixels is drawn on the outside edges of the display.

The program takes the `compass.heading` and, using some simple yet cunning maths, [floor division](#) `//` and [modulo](#) `%`, works out the number of the clock hand to use to display on the screen so that it is pointing roughly North.

1.10 Storage

Sometimes you need to store useful information. Such information is stored as data: representation of information (in a digital form when stored on computers). If you store data on a computer it should persist, even if you switch the device off and on again.

Happily MicroPython on the micro:bit allows you to do this with a very simple file system. Because of memory constraints **there is approximately 30k of storage available** on the file system.

Note: The micropython file system should not be confused with the micro:bit mass storage mode which presents the device as a USB drive. Mass storage mode is only intended for copying across a HEX file, so you won't see files you create using the file system appearing on the MICROBIT drive.

What is a file system?

It's a means of storing and organising data in a persistent manner - any data stored in a file system should survive restarts of the device. As the name suggests, data stored on a file system is organised into files.

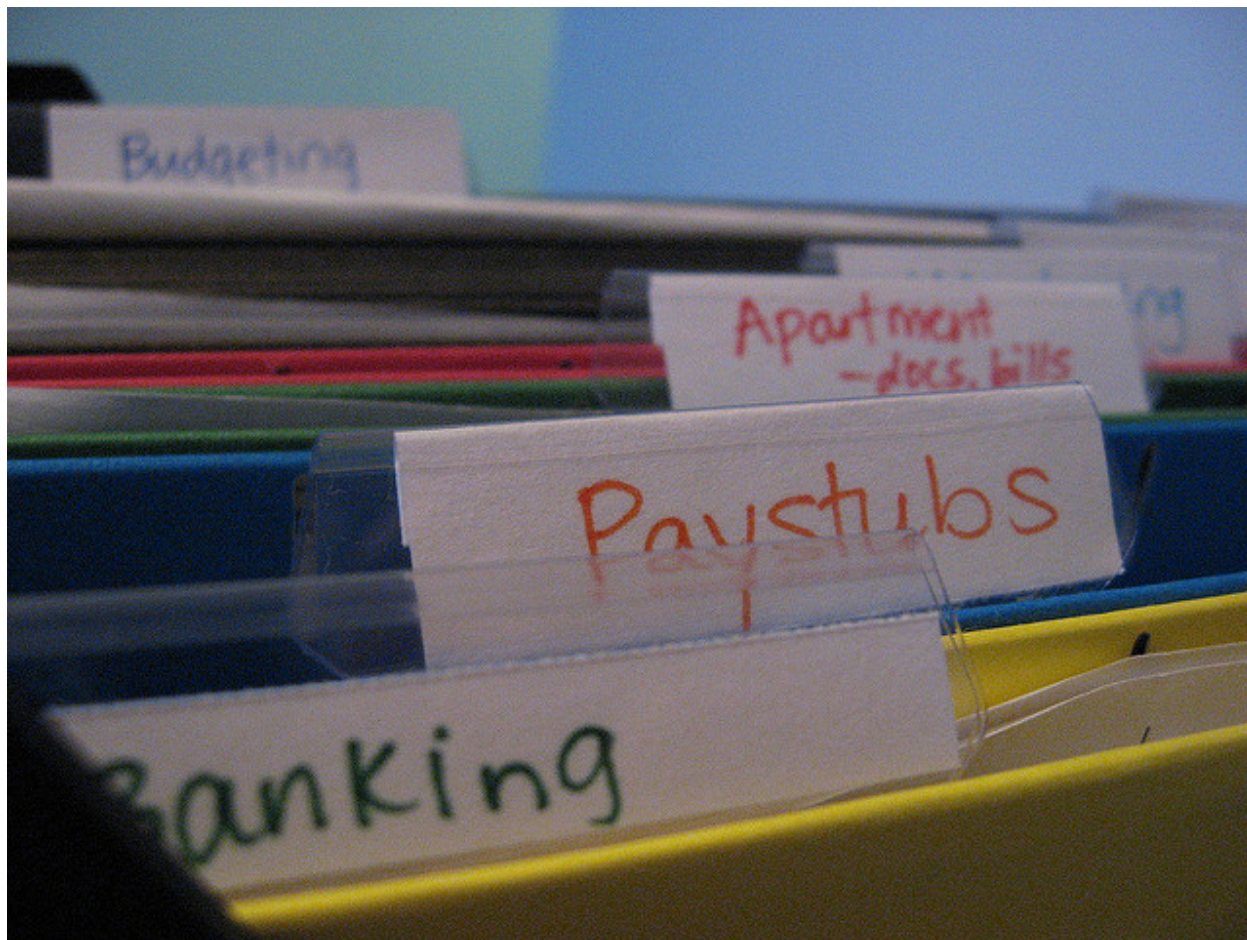

A computer file is a named digital resource that's stored on a file system. Such resources contain useful information as data. This is exactly how a paper file works. It's a sort of named container that contains useful information. Usually, both paper and digital files are named to indicate what they contain. On computers it is common to end a file with a `.something` suffix. Usually, the "something" indicates what type of data is used to represent the information. For example, `.txt` indicates a text file, `.jpg` a JPEG image and `.mp3` sound data encoded as MP3.

Some file systems (such as the one found on your laptop or PC) allow you to organise your files into directories: named containers that group related files and sub-directories together. However, *the file system provided by MicroPython is a flat file system*. A flat file system does not have directories - all your files are just stored in the same place.

The Python programming language contains easy to use and powerful ways in which to work with a computer's file system. MicroPython on the micro:bit implements a useful subset of these features to make it easy to read and write files on the device, while also providing consistency with other versions of Python.

Warning: Flashing your micro:bit will DESTROY ALL YOUR DATA since it re-writes all the flash memory used by the device and the file system is stored in the flash memory.

However, if you switch off your device the data will remain intact until you either delete it or re-flash the device.

1.10.1 Open Sesame

Reading and writing a file on the file system is achieved by the `open` function. Once a file is opened you can do stuff with it until you close it (analogous with the way we use paper files). It is essential you close a file so MicroPython knows you've finished with it.

The best way to make sure of this is to use the `with` statement like this:

```
with open('story.txt') as my_file:
    content = my_file.read()
print(content)
```

The `with` statement uses the `open` function to open a file and assign it to an object. In the example above, the `open` function opens the file called `story.txt` (obviously a text file containing a story of some sort). The object that's used to represent the file in the Python code is called `my_file`. Subsequently, in the code block indented underneath the `with` statement, the `my_file` object is used to `read()` the content of the file and assign it to the `content` object.

Here's the important point, *the next line containing the print statement is not indented*. The code block associated with the `with` statement is only the single line that reads the file. Once the code block associated with the `with` statement is closed then Python (and MicroPython) will automatically close the file for you. This is called context handling and the `open` function creates objects that are context handlers for files.

Put simply, the scope of your interaction with a file is defined by the code block associated with the `with` statement that opens the file.

Confused?

Don't be. I'm simply saying your code should look like this:

```
with open('some_file') as some_object:
    # Do stuff with some_object in this block of code
    # associated with the with statement.

# When the block is finished then MicroPython
# automatically closes the file for you.
```

Just like a paper file, a digital file is opened for two reasons: to read its content (as demonstrated above) or to write something to the file. The default mode is to read the file. If you want to write to a file you need to tell the `open` function in the following way:

```
with open('hello.txt', 'w') as my_file:
    my_file.write("Hello, World!")
```

Notice the `'w'` argument is used to set the `my_file` object into write mode. You could also pass an `'r'` argument to set the file object to read mode, but since this is the default, it's often left off.

Writing data to the file is done with the (you guessed it) `write` method that takes the string you want to write to the file as an argument. In the example above, I write the text “Hello, World!” to a file called “hello.txt”.

Simple!

Note: When you open a file and write (perhaps several times while the file is in an open state) you will be writing OVER the content of the file if it already exists.

If you want to append data to a file you should first read it, store the content somewhere, close it, append your data to the content and then open it to write again with the revised content.

While this is the case in MicroPython, “normal” Python can open files to write in “append” mode. That we can't do this on the micro:bit is a result of the simple implementation of the file system.

1.10.2 OS SOS

As well as reading and writing files, Python can manipulate them. You certainly need to know what files are on the file system and sometimes you need to delete them too.

On a regular computer, it is the role of the operating system (like Windows, OSX or Linux) to manage this on Python's behalf. Such functionality is made available in Python via a module called `os`. Since MicroPython **is** the operating system we've decided to keep the appropriate functions in the `os` module for consistency so you'll know where to find them when you use “regular” Python on a device like a laptop or Raspberry Pi.

Essentially, you can do three operations related to the file system: list the files, remove a file and ask for the size of a file.

To list the files on your file system use the `listdir` function. It returns a list of strings indicating the file names of the files on the file system:

```
import os
my_files = os.listdir()
```

To delete a file use the `remove` function. It takes a string representing the file name of the file you want to delete as an argument, like this:

```
import os
os.remove('filename.txt')
```

Finally, sometimes it's useful to know how big a file is before reading from it. To achieve this use the `size` function. Like the `remove` function, it takes a string representing the file name of the file whose size you want to know. It returns an integer (whole number) telling you the number of bytes the file takes up:

```
import os
file_size = os.size('a_big_file.txt')
```

It's all very well having a file system, but what if we want to put or get files on or off the device?

Just use the `microfs` utility!

1.10.3 File Transfer

If you have Python installed on the computer you use to program your BBC micro:bit then you can use a special utility called `microfs` (shortened to `ufs` when using it in the command line). Full instructions for installing and using all the features of `microfs` can be found [in its documentation](#).

Nevertheless it's possible to do most of the things you need with just four simple commands:

```
$ ufs ls
story.txt
```

The `ls` sub-command lists the files on the file system (it's named after the common Unix command, `ls`, that serves the same function).

```
$ ufs get story.txt
```

The `get` sub-command gets a file from the connected micro:bit and saves it into your current location on your computer (it's named after the `get` command that's part of the common file transfer protocol [FTP] that serves the same function).

```
$ ufs rm story.txt
```

The `rm` sub-command removes the named file from the file system on the connected micro:bit (it's named after the common Unix command, `rm`, that serves the same function).

```
$ ufs put story2.txt
```

Finally, the `put` sub-command puts a file from your computer onto the connected device (it's named after the `put` command that's part of FTP that serves the same function).

1.10.4 Mainly `main.py`

The file system also has an interesting property: if you just flashed the MicroPython runtime onto the device then when it starts it's simply waiting for something to do. However, if you copy a special file called `main.py` onto the file system, upon restarting the device, MicroPython will run the contents of the `main.py` file.

Furthermore, if you copy other Python files onto the file system then you can `import` them as you would any other Python module. For example, if you had a `hello.py` file that contained the following simple code:

```
def say_hello(name="World") :
    return "Hello, {}".format(name)
```

...you could import and use the `say_hello` function like this:

```
from microbit import display
from hello import say_hello

display.scroll(say_hello())
```

Of course, it results in the text "Hello, World!" scrolling across the display. The important point is that such an example is split between two Python modules and the `import` statement is used to share code.

Note: If you have flashed a script onto the device in addition to the MicroPython runtime, then MicroPython will ignore `main.py` and run your embedded script instead.

To flash just the MicroPython runtime, simply make sure the script you may have written in your editor has zero characters in it. Once flashed you'll be able to copy over a `main.py` file.

1.11 Speech

Warning: WARNING! THIS IS ALPHA CODE.

We reserve the right to change this API as development continues.

The quality of the speech is not great, merely “good enough”. Given the constraints of the device you may encounter memory errors and / or unexpected extra sounds during playback. It's early days and we're improving the code for the speech synthesiser all the time. Bug reports and pull requests are most welcome.

Computers and robots that talk feel more “human”.

So often we learn about what a computer is up to through a graphical user interface (GUI). In the case of a BBC micro:bit the GUI is a 5x5 LED matrix, which leaves a lot to be desired.

Getting the micro:bit talk to you is one way to express information in a fun, efficient and useful way. To this end, we have integrated a simple speech synthesiser based upon a reverse-engineered version of a synthesiser from the early 1980s. It sounds very cute, in an “all humans must die” sort of a way.

With this in mind, we're going to use the speech synthesiser to create...

1.11.1 DALEK Poetry



It's a little known fact that DALEKs enjoy poetry ~ especially limericks. They go wild for anapestic meter with a strict AABBA form. Who'd have thought?

(Actually, as we'll learn below, it's The Doctor's fault DALEKs like limericks, much to the annoyance of Davros.)

In any case, we're going to create a DALEK poetry recital on demand.

1.11.2 Say Something

Before the device can talk you need to plug in a speaker like this:

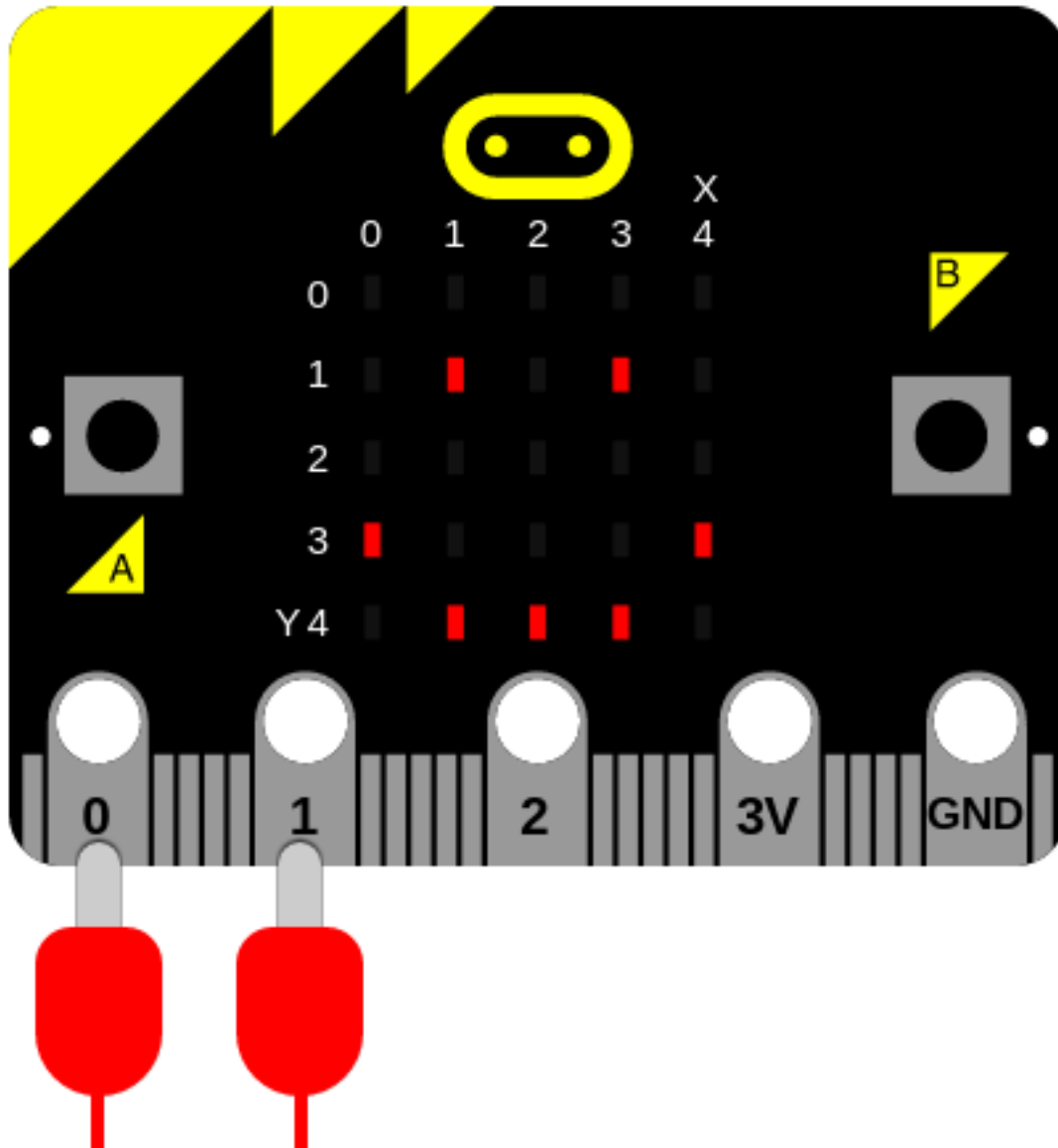

The simplest way to get the device to speak is to import the `speech` module and use the `say` function like this:

```
import speech
speech.say("Hello, World")
```

While this is cute it's certainly not DALEK enough for our taste, so we need to change some of the parameters that the speech synthesiser uses to produce the voice. Our speech synthesiser is quite powerful in this respect because we can change four parameters:

- `pitch` - how high or low the voice sounds (0 = high, 255 = Barry White)
- `speed` - how quickly the device talks (0 = impossible, 255 = bedtime story)
- `mouth` - how tight-lipped or overtly enunciating the voice sounds (0 = ventriloquist's dummy, 255 = Foghorn Leghorn)
- `throat` - how relaxed or tense is the tone of voice (0 = falling apart, 255 = totally chilled)

Collectively, these parameters control the quality of sound - a.k.a. the timbre. To be honest, the best way to get the tone of voice you want is to experiment, use your judgement and adjust.

To adjust the settings you pass them in as arguments to the `say` function. More details can be found in the `speech` module's API documentation.

After some experimentation we've worked out this sounds quite DALEK-esque:

```
speech.say("I am a DALEK - EXTERMINATE", speed=120, pitch=100, throat=100, mouth=200)
```

1.11.3 Poetry on Demand

Being Cyborgs DALEKs use their robot capabilities to compose poetry and it turns out that the algorithm they use is written in Python like this:

```
# DALEK poetry generator, by The Doctor
import speech
import random
from microbit import sleep

# Randomly select fragments to interpolate into the template.
location = random.choice(["brent", "trent", "kent", "tashkent"])
action = random.choice(["wrapped up", "covered", "sang to", "played games with"])
obj = random.choice(["head", "hand", "dog", "foot"])
prop = random.choice(["in a tent", "with cement", "with some scent",
                     "that was bent"])
result = random.choice(["it ran off", "it glowed", "it blew up",
                       "it turned blue"])
attitude = random.choice(["in the park", "like a shark", "for a lark",
                          "with a bark"])
conclusion = random.choice(["where it went", "its intent", "why it went",
                           "what it meant"])

# A template of the poem. The {} are replaced by the named fragments.
poem = [
    "there was a young man from {}".format(location),
    "who {} his {} {}".format(action, obj, prop),
    "one night after dark",
    "{} {}".format(result, attitude),
    "and he never worked out {}".format(conclusion),
    "EXTERMINATE",
]

# Loop over each line in the poem and use the speech module to recite it.
for line in poem:
```

(continues on next page)

(continued from previous page)

```
speech.say(line, speed=120, pitch=100, throat=100, mouth=200)
sleep(500)
```

As the comments demonstrate, it's a very simple in design:

- Named fragments (`location`, `prop`, `attitude` etc) are randomly generated from pre-defined lists of possible values. Note the use of `random.choice` to select a single item from a list.
- A template of a poem is defined as a list of stanzas with “holes” in them (denoted by `{ }`) into which the named fragments will be put using the `format` method.
- Finally, Python loops over each item in the list of filled-in poetry stanzas and uses `speech.say` with the settings for the DALEK voice to recite the poem. A pause of 500 milliseconds is inserted between each line because even DALEKs need to take a breath.

Interestingly the original poetry related routines were written by Davros in **FORTTRAN** (an appropriate language for DALEKS since you type it ALL IN CAPITAL LETTERS). However, The Doctor went back in time to precisely the point between Davros's [unit tests](#) passing and the [deployment pipeline](#) kicking in. At this instant he was able to insert a MicroPython interpreter into the DALEK operating system and the code you see above into the DALEK memory banks as a sort of long hidden Time-Lord [Easter Egg](#) or [Rickroll](#).

1.11.4 Phonemes

You'll notice that sometimes, the `say` function doesn't accurately translate from English words into the correct sound. To have fine grained control of the output, use phonemes: the building-block sounds of language.

The advantage of using phonemes is that you don't have to know how to spell! Rather, you only have to know how to say the word in order to spell it phonetically.

A full list of the phonemes the speech synthesiser understands can be found in the API documentation for `speech`. Alternatively, save yourself a lot of time by passing in English words to the `translate` function. It'll return a first approximation of the phonemes it would use to generate the audio. This result can be hand-edited to improve the accuracy, inflection and emphasis (so it sounds more natural).

The `pronounce` function is used for phoneme output like this:

```
speech.pronounce("/HEH5EH4EH3EH2EH2EH3EH4EH5EHLPL.")
```

How could you improve on The Doctor's code to make it use phonemes?

1.11.5 Sing A Song of Micro:bit

By changing the `pitch` setting and calling the `sing` function it's possible to make the device sing (although it's not going to win Eurovision any time soon).

The mapping from pitch numbers to musical notes is shown below:

The image displays two systems of musical notation. The first system consists of a grand staff with a treble clef on the upper staff and a bass clef on the lower staff. The bass staff contains a sequence of notes with pitch values written below them: 115 108 103 98, 94 88 82 78, 74 70 66 62. The treble staff is mostly empty, with a few notes and pitch values (58 55 52 49) appearing in the final measure. The second system also consists of a grand staff. The treble staff contains a sequence of notes with pitch values written below them: 46 44 42 39, 37 35 33 31, 29 28 26 25, 23 22 21 20. The bass staff is empty in this system.

The `sing` function must take phonemes and pitch as input like this:

```
speech.sing("#115DOWWWW")
```

Notice how the pitch to be sung is prepended to the phoneme with a hash (#). The pitch will remain the same for subsequent phonemes until a new pitch is annotated.

The following example demonstrates how all three generative functions (`say`, `pronounce` and `sing`) can be used to produce speech like output:

```
import speech
from microbit import sleep

# The say method attempts to convert English into phonemes.
speech.say("I can sing!")
sleep(1000)
speech.say("Listen to me!")
sleep(1000)

# Clearing the throat requires the use of phonemes. Changing
# the pitch and speed also helps create the right effect.
speech.pronounce("AEAE/HAEMM", pitch=200, speed=100) # Ahem
sleep(1000)

# Singing requires a phoneme with an annotated pitch for each syllable.
solfa = [
    "#115DOWWWW", # Doh
    "#103REYYYYY", # Re
    "#94MIYYYYY", # Mi
    "#88FAOAOAOAOR", # Fa
    "#78SOHWWW", # Soh
```

(continues on next page)

(continued from previous page)

```
    "#70LAOAOAOAOR", # La
    "#62TIYYYYYY",  # Ti
    "#58DOWWWWWW",  # Doh
]

# Sing the scale ascending in pitch.
song = ''.join(solfa)
speech.sing(song, speed=100)
# Reverse the list of syllables.
solfa.reverse()
song = ''.join(solfa)
# Sing the scale descending in pitch.
speech.sing(song, speed=100)
```

1.12 Network

It is possible to connect devices together to send and receive messages to and from each other. This is called a network. A network of interconnected networks is called an internet. The Internet is an internet of all the internets.

Networking is hard and this is reflected in the program described below. However, the beautiful thing about this project is it contains all the common aspects of network programming you need to know about. It's also remarkably simple and fun.

But first, let's set the scene...

1.12.1 Connection

Imagine a network as a series of layers. At the very bottom is the most fundamental aspect of communication: there needs to be some sort of way for a signal to get from one device to the other. Sometimes this is done via a radio connection, but in this example we're simply going to use two wires.

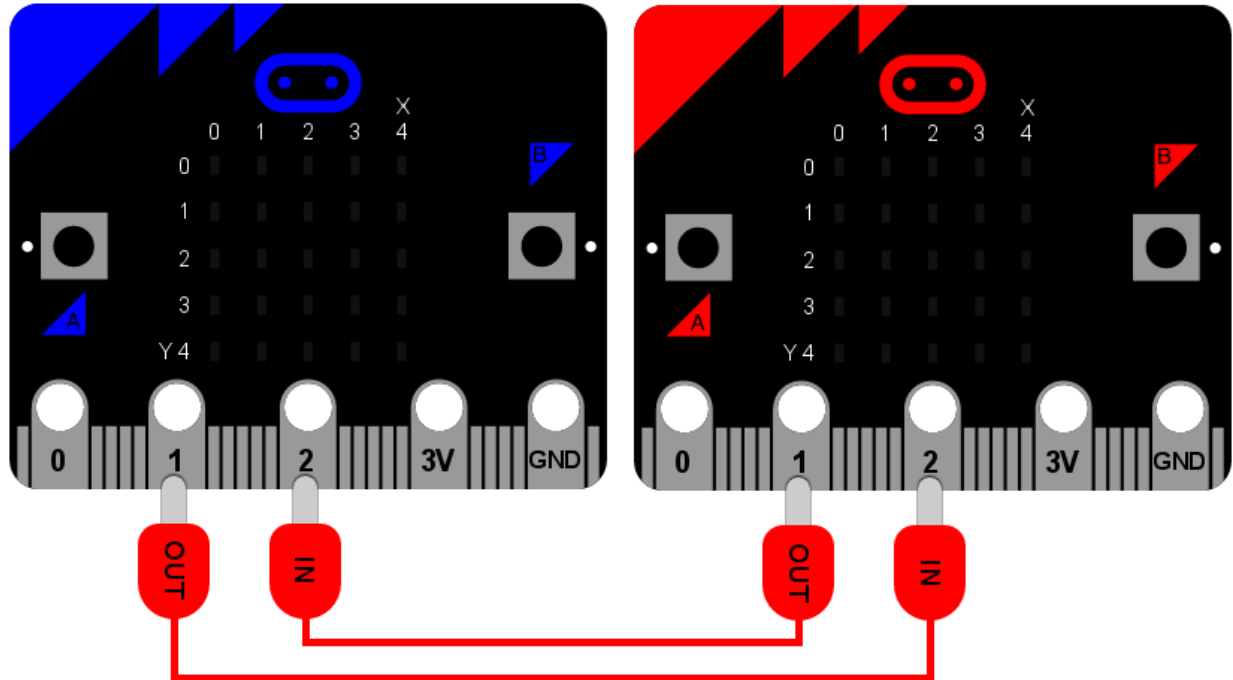

It is upon this foundation that we can build all the other layers in the *network stack*.

As the diagram shows, blue and red micro:bits are connected via crocodile leads. Both use pin 1 for output and pin 2 for input. The output from one device is connected to the input on the other. It's a bit like knowing which way round to hold a telephone handset - one end has a microphone (the input) and the other a speaker (the output). The recording of your voice via your microphone is played out of the other person's speaker. If you hold the phone the wrong way up, you'll get strange results!

It's exactly the same in this instance: you must connect the wires properly!

1.12.2 Signal

The next layer in the *network stack* is the signal. Often this will depend upon the characteristics of the connection. In our example it's simply digital on and off signals sent down the wires via the IO pins.

If you remember, it's possible to use the IO pins like this:

```
pin1.write_digital(1) # switch the signal on
pin1.write_digital(0) # switch the signal off
input = pin2.read_digital() # read the value of the signal (either 1 or 0)
```

The next step involves describing how to use and handle a signal. For that we need a...

1.12.3 Protocol

If you ever meet the Queen there are expectations about how you ought to behave. For example, when she arrives you may bow or curtsy, if she offers her hand politely shake it, refer to her as "your majesty" and thereafter as "ma'am" and so on. This set of rules is called the royal protocol. A protocol explains how to behave given a specific situation (such as meeting the Queen). A protocol is pre-defined to ensure everyone understands what's going on before a given situation arises.



It is for this reason that we define and use protocols for communicating messages via a computer network. Computers need to agree before hand how to send and receive messages. Perhaps the best known protocol is the hypertext transfer protocol (HTTP) used by the world wide web.

Another famous protocol for sending messages (that pre-dates computers) is Morse code. It defines how to send character-based messages via on/off signals of long or short durations. Often such signals are played as bleeps. Long durations are called dashes (-) whereas short durations are dots (.). By combining dashes and dots Morse defines a way to send characters. For example, here's how the standard Morse alphabet is defined:

.-	A	.-.-.-	J	...	S	.-.-.-.-	1	-----.	9
-...	B	-.-	K	-	T	..-.-.-	2	-----	0
-.-.-	C	.-.-.	L	..-	U	...-.-	3		
-..	D	--	M	...-	V	...-.-	4		
.	E	-.	N	.-.-	W	5		
..-.	F	---.	O	-.-.-	X	-.....	6		
---.	G	---.	P	-.-.-	Y	-.-.-.-	7		
....	H	--.-	Q	--..	Z	-----	8		
..	I	.-.	R						

Given the chart above, to send the character “H” the signal is switched on four times for a short duration, indicating four dots (. . . .). For the letter “L” the signal is also switched on four times, but the second signal has a longer duration (. - . .).

Obviously, the timing of the signal is important: we need to tell a dot from a dash. That’s another point of a protocol, to agree such things so everyone’s implementation of the protocol will work with everyone else’s. In this instance we’ll just say that:

- A signal with a duration less than 250 milliseconds is a dot.
- A signal with a duration from 250 milliseconds to less than 500 milliseconds is a dash.
- Any other duration of signal is ignored.
- A pause / gap in the signal of greater than 500 milliseconds indicates the end of a character.

In this way, the sending of a letter “H” is defined as four “on” signals that last no longer than 250 milliseconds each, followed by a pause of greater than 500 milliseconds (indicating the end of the character).

1.12.4 Message

We're finally at a stage where we can build a message - a message that actually means something to us humans. This is the top-most layer of our *network stack*.

Using the protocol defined above I can send the following sequence of signals down the physical wire to the other micro:bit:

```
.... / . / . - . . / . - . . / - - - / . - - / - - - / . - . / . - . . / - . .
```

Can you work out what it says?

1.12.5 Application

It's all very well having a network stack, but you also need a way to interact with it - some form of application to send and receive messages. While HTTP is interesting *most* people don't know about it and let their web-browser handle it - the underlying *network stack* of the world wide web is hidden (as it should be).

So, what sort of application should we write for the BBC micro:bit? How should it work, from the user's point of view?

Obviously, to send a message you should be able to input dots and dashes (we can use button A for that). If we want to see the message we sent or just received we should be able to trigger it to scroll across the display (we can use button B for that). Finally, this being Morse code, if a speaker is attached, we should be able to play the beeps as a form of aural feedback while the user is entering their message.

1.12.6 The End Result

Here's the program, in all its glory and annotated with plenty of comments so you can see what's going on:

```
from microbit import *
import music

# A lookup table of morse codes and associated characters.
MORSE_CODE_LOOKUP = {
    ".-": "A",
    "-...": "B",
    "-.-": "C",
    "-..": "D",
    ".": "E",
    "..-": "F",
    "--": "G",
    "...": "H",
    ". .": "I",
    ".---": "J",
    "-.-": "K",
    "-...": "L",
    "--": "M",
    "- .": "N",
    "---": "O",
    ".--": "P",
    "--.-": "Q",
    "- .": "R",
    "...": "S",
```

(continues on next page)

(continued from previous page)

```

"-": "T",
"..-": "U",
"...-": "V",
".--": "W",
"-.-": "X",
"-.--": "Y",
"--.": "Z",
".----": "1",
"..---": "2",
"...--": "3",
"...-.": "4",
".....": "5",
"-....": "6",
"--...": "7",
"---..": "8",
"----.": "9",
"-----": "0"
}

def decode(buffer):
    # Attempts to get the buffer of Morse code data from the lookup table. If
    # it's not there, just return a full stop.
    return MORSE_CODE_LOOKUP.get(buffer, '.')

# How to display a single dot.
DOT = Image("00000:"
            "00000:"
            "00900:"
            "00000:"
            "00000:")

# How to display a single dash.
DASH = Image("00000:"
             "00000:"
             "09990:"
             "00000:"
             "00000:")

# To create a DOT you need to hold the button for less than 250ms.
DOT_THRESHOLD = 250
# To create a DASH you need to hold the button for less than 500ms.
DASH_THRESHOLD = 500

# Holds the incoming Morse signals.
buffer = ''
# Holds the translated Morse as characters.
message = ''
# The time from which the device has been waiting for the next keypress.
started_to_wait = running_time()

# Put the device in a loop to wait for and react to key presses.

```

(continues on next page)

(continued from previous page)

```

while True:
    # Work out how long the device has been waiting for a keypress.
    waiting = running_time() - started_to_wait
    # Reset the timestamp for the key_down_time.
    key_down_time = None
    # If button_a is held down, then...
    while button_a.is_pressed():
        # Play a beep - this is Morse code y'know ;-)
        music.pitch(880, 10)
        # Set pin1 (output) to "on"
        pin1.write_digital(1)
        # ...and if there's not a key_down_time then set it to now!
        if not key_down_time:
            key_down_time = running_time()
    # Alternatively, if pin2 (input) is getting a signal, pretend it's a
    # button_a key press...
    while pin2.read_digital():
        if not key_down_time:
            key_down_time = running_time()
    # Get the current time and call it key_up_time.
    key_up_time = running_time()
    # Set pin1 (output) to "off"
    pin1.write_digital(0)
    # If there's a key_down_time (created when button_a was first pressed
    # down).
    if key_down_time:
        # ... then work out for how long it was pressed.
        duration = key_up_time - key_down_time
        # If the duration is less than the max length for a "dot" press...
        if duration < DOT_THRESHOLD:
            # ... then add a dot to the buffer containing incoming Morse codes
            # and display a dot on the display.
            buffer += '.'
            display.show(DOT)
        # Else, if the duration is less than the max length for a "dash"
        # press... (but longer than that for a DOT ~ handled above)
        elif duration < DASH_THRESHOLD:
            # ... then add a dash to the buffer and display a dash.
            buffer += '-'
            display.show(DASH)
        # Otherwise, any other sort of keypress duration is ignored (this isn't
        # needed, but added for "understandability").
        else:
            pass
    # The button press has been handled, so reset the time from which the
    # device is starting to wait for a button press.
    started_to_wait = running_time()
    # Otherwise, there hasn't been a button_a press during this cycle of the
    # loop, so check there's not been a pause to indicate an end of the
    # incoming Morse code character. The pause must be longer than a DASH
    # code's duration.
    elif len(buffer) > 0 and waiting > DASH_THRESHOLD:
        # There is a buffer and it's reached the end of a code so...
        # Decode the incoming buffer.
        character = decode(buffer)
        # Reset the buffer to empty.
        buffer = ''

```

(continues on next page)

(continued from previous page)

```
    # Show the decoded character.
    display.show(character)
    # Add the character to the message.
    message += character
# Finally, if button_b was pressed while all the above was going on...
if button_b.was_pressed():
    # ... display the message,
    display.scroll(message)
    # then reset it to empty (ready for a new message).
    message = ''
```

How would you improve it? Can you change the definition of a dot and a dash so speedy Morse code users can use it? What happens if both devices are sending at the same time? What might you do to handle this situation?

1.13 Radio

Interaction at a distance feels like magic.

Magic might be useful if you're an elf, wizard or unicorn, but such things only exist in stories.

However, there's something much better than magic: physics!

Wireless interaction is all about physics: radio waves (a type of electromagnetic radiation, similar to visible light) have some sort of property (such as their amplitude, phase or pulse width) modulated by a transmitter in such a way that information can be encoded and, thus, broadcast. When radio waves encounter an electrical conductor (i.e. an aerial), they cause an alternating current from which the information in the waves can be extracted and transformed back into its original form.

1.13.1 Layers upon Layers

If you remember, networks are built in layers.

The most fundamental requirement for a network is some sort of connection that allows a signal to get from one device to the other. In our networking tutorial we used wires connected to the I/O pins. Thanks to the radio module we can do away with wires and use the physics summarised above as the invisible connection between devices.

The next layer up in the network stack is also different from the example in the networking tutorial. With the wired example we used digital on and off to send and read a signal from the pins. With the built-in radio on the micro:bit the smallest useful part of the signal is a byte.

1.13.2 Bytes

A byte is a unit of information that (usually) consists of eight bits. A bit is the smallest possible unit of information since it can only be in two states: on or off.

Bytes work like a sort of abacus: each position in the byte is like a column in an abacus - they represent an associated number. In an abacus these are usually thousands, hundreds, tens and units (in UK parlance). In a byte they are 128, 64, 32, 16, 8, 4, 2 and 1. As bits (on/off signals) are sent over the air, they are re-combined into bytes by the recipient.

Have you spotted the pattern? (Hint: base 2.)

By adding the numbers associated with the positions in a byte that are set to "on" we can represent numbers between 0 and 255. The image below shows how this works with five bits and counting from zero to 32:

If we can agree what each one of the 255 numbers (encoded by a byte) represents ~ such as a character ~ then we can start to send text one character per byte at a time.

Funnily enough, people have already [thought of this](#) ~ using bytes to encode and decode information is commonplace. This approximately corresponds to the Morse-code “protocol” layer in the wired networking example.

A really great series of child (and teacher) friendly explanations of “all things bytes” can be found at the [CS unplugged](#) website.

1.13.3 Addressing

The problem with radio is that you can’t transmit directly to one person. Anyone with an appropriate aerial can receive the messages you transmit. As a result it’s important to be able to differentiate who should be receiving broadcasts.

The way the radio built into the micro:bit solves this problem is quite simple:

- It’s possible to tune the radio to different channels (numbered 0-83). This works in exactly the same way as kids’ walkie-talkie radios: everyone tunes into the same channel and everyone hears what everyone else broadcasts via that channel. As with walkie-talkies, if you use adjacent channels there is a slight possibility of interference.
- The radio module allows you to specify two pieces of information: an address and a group. The address is like a postal address whereas a group is like a specific recipient at the address. The important thing is the radio will filter out messages that it receives that do not match *your* address and group. As a result, it’s important to pre-arrange the address and group your application is going to use.

Of course, the micro:bit is still receiving broadcast messages for other address/group combinations. The important thing is you don’t need to worry about filtering those out. Nevertheless, if someone were clever enough, they could just read *all the wireless network traffic* no matter what the target address/group was supposed to be. In this case, it’s *essential* to use encrypted means of communication so only the desired recipient can actually read the message that was broadcast. Cryptography is a fascinating subject but, unfortunately, beyond the scope of this tutorial.

1.13.4 Fireflies

This is a firefly:

It’s a sort of bug that uses bioluminescence to signal (without wires) to its friends. Here’s what they look like when they signal to each other:

The BBC have [rather a beautiful video](#) of fireflies available online.

We’re going to use the radio module to create something akin to a swarm of fireflies signalling to each other.

First `import radio` to make the functions available to your Python program. Then call the `radio.on()` function to turn the radio on. Since the radio draws power and takes up memory we’ve made it so *you* decide when it is enabled (there is, of course a `radio.off()` function).

At this point the radio module is configured to sensible defaults that make it compatible with other platforms that may target the BBC micro:bit. It is possible to control many of the features discussed above (such as channel and addressing) as well as the amount of power used to broadcast messages and the amount of RAM the incoming message queue will take up. The API documentation contains all the information you need to configure the radio to your needs.

Assuming we’re happy with the defaults, the simplest way to send a message is like this:

```
radio.send("a message")
```

The example uses the `send` function to simply broadcast the string “a message”. To receive a message is even easier:

```
new_message = radio.receive()
```

As messages are received they are put on a message queue. The `receive` function returns the oldest message from the queue as a string, making space for a new incoming message. If the message queue fills up, then new incoming messages are ignored.

That’s really all there is to it! (Although the radio module is also powerful enough that you can send any arbitrary type of data, not just strings. See the API documentation for how this works.)

Armed with this knowledge, it’s simple to make micro:bit fireflies like this:

```
# A micro:bit Firefly.
# By Nicholas H.Tollervey. Released to the public domain.
import radio
import random
from microbit import display, Image, button_a, sleep

# Create the "flash" animation frames. Can you work out how it's done?
flash = [Image().invert()*(i/9) for i in range(9, -1, -1)]

# The radio won't work unless it's switched on.
radio.on()

# Event loop.
while True:
    # Button A sends a "flash" message.
    if button_a.was_pressed():
        radio.send('flash') # a-ha
    # Read any incoming messages.
    incoming = radio.receive()
    if incoming == 'flash':
        # If there's an incoming "flash" message display
        # the firefly flash animation after a random short
        # pause.
        sleep(random.randint(50, 350))
        display.show(flash, delay=100, wait=False)
        # Randomly re-broadcast the flash message after a
        # slight delay.
        if random.randint(0, 9) == 0:
            sleep(500)
            radio.send('flash') # a-ha
```

The important stuff happens in the event loop. First, it checks if button A was pressed and, if it was, uses the radio to send the message “flash”. Then it reads any messages from the message queue with `radio.receive()`. If there is a message it sleeps a short, random period of time (to make the display more interesting) and uses `display.show()` to animate a firefly flash. Finally, to make things a bit exciting, it chooses a random number so that it has a 1 in 10 chance of re-broadcasting the “flash” message to anyone else (this is how it’s possible to sustain the firefly display among several devices). If it decides to re-broadcast then it waits for half a second (so the display from the initial flash message has chance to die down) before sending the “flash” signal again. Because this code is enclosed within a `while True` block, it loops back to the beginning of the event loop and repeats this process forever.

The end result (using a group of micro:bits) should look something like this:

1.14 Next Steps

These tutorials are only the first steps in using MicroPython with the BBC micro:bit. A musical analogy: you've got a basic understanding of a very simple instrument and confidently play "Three Blind Mice".

This is an achievement to build upon.

Ahead of you is an exciting journey to becoming a virtuoso coder.

You will encounter frustration, failure and foolishness. When you do please remember that you're not alone. Python has a secret weapon: the most amazing community of programmers on the planet. Connect with this community and you will make friends, find mentors, support each other and share resources.

The examples in the tutorials are simple to explain but may not be the simplest or most efficient implementations. We've left out lots of *really fun stuff* so we could concentrate on arming you with the basics. If you *really* want to know how to make MicroPython fly on the BBC micro:bit then read the API reference documentation. It contains information about *all* the capabilities available to you.

Explore, experiment and be fearless trying things out ~ for these are the attributes of a virtuoso coder. To encourage you we have hidden a number of [Easter eggs](#) in MicroPython and the Python code editors. They're fun rewards for looking "under the hood" and "poking with a stick".

Such skill in Python is valuable: it's one of the world's most popular professional programming languages.

Amaze us with your code! Make things that delight us! Most of all, have fun!

Happy hacking!

Python is one of the [world's most popular](#) programming languages. Every day, without realising, you probably use software written using Python. All sorts of companies and organisations use Python for a diverse range of applications. Google, NASA, Bank of America, Disney, CERN, YouTube, Mozilla, The Guardian - the list goes on and covers all sectors of the economy, science and the arts.

For example, do you remember the announcement of the [discovery of gravitational waves](#)? The instruments used to make the measurements were controlled [with Python](#).

Put simply, if you teach or learn Python, you are developing a highly valuable skill that applies to all areas of human endeavour.

One such area is the BBC's amazing micro:bit device. It runs a version of Python called MicroPython that's designed to run on small computers like the BBC micro:bit. It's a full implementation of Python 3 so when you move onto other things (such as programming Python on a Raspberry Pi) you'll use exactly the same language.

MicroPython does not include all the standard code libraries that come with "regular" Python. However, we have created a special `microbit` module in MicroPython that lets you control the device.

Python and MicroPython are free software. Not only does this mean you don't pay anything to use Python, but you are also free to contribute back to the Python community. This may be in the form of code, documentation, bug reports, running a community group or writing tutorials (like this one). In fact, all the Python related resources for the BBC micro:bit have been created by an international team of volunteers working in their free time.

These lessons introduce MicroPython and the BBC micro:bit in easy-to-follow steps. Feel free to adopt and adapt them for classroom based lessons, or perhaps just follow them on your own at home.

You'll have most success if you explore, experiment and play. You can't break a BBC micro:bit by writing incorrect code. Just dive in!

A word of warning: *you will fail many times*, and that is fine. **Failure is how good software developers learn.** Those of us who work as software developers have a lot of fun tracking down bugs and avoiding the repetition of mistakes.

If in doubt, remember the Zen of MicroPython:

```
Code,  
Hack it,  
Less is more,  
Keep it simple,  
Small is beautiful,  
  
Be brave! Break things! Learn and have fun!  
Express yourself with MicroPython.  
  
Happy hacking! :-)
```

Best of luck!

2.1 The microbit module

Everything directly related to interacting with the hardware lives in the *microbit* module. For ease of use it's recommended you start all scripts with:

```
from microbit import *
```

The following documentation assumes you have done this.

There are a few functions available directly:

```
# sleep for the given number of milliseconds.
sleep(ms)
# returns the number of milliseconds since the micro:bit was last switched on.
running_time()
# makes the micro:bit enter panic mode (this usually happens when the DAL runs
# out of memory, and causes a sad face to be drawn on the display). The error
# code can be any arbitrary integer value.
panic(error_code)
# resets the micro:bit.
reset()
```

The rest of the functionality is provided by objects and classes in the *microbit* module, as described below.

Note that the API exposes integers only (ie no floats are needed, but they may be accepted). We thus use milliseconds for the standard time unit.

Note: You can see a list of all available modules by writing `help('modules')` in the REPL.

2.1.1 Buttons

There are 2 buttons:

```
button_a
button_b
```

These are both objects and have the following methods:

```
# returns True or False to indicate if the button is pressed at the time of
# the method call.
button.is_pressed()
# returns True or False to indicate if the button was pressed since the device
# started or the last time this method was called.
button.was_pressed()
# returns the running total of button presses, and resets this counter to zero
button.get_presses()
```

2.1.2 The LED display

The LED display is exposed via the *display* object:

```
# gets the brightness of the pixel (x,y). Brightness can be from 0 (the pixel
# is off) to 9 (the pixel is at maximum brightness).
display.get_pixel(x, y)
# sets the brightness of the pixel (x,y) to val (between 0 [off] and 9 [max
# brightness], inclusive).
display.set_pixel(x, y, val)
# clears the display.
display.clear()
# shows the image.
display.show(image, delay=0, wait=True, loop=False, clear=False)
# shows each image or letter in the iterable, with delay ms. in between each.
display.show(iterable, delay=400, wait=True, loop=False, clear=False)
# scrolls a string across the display (more exciting than display.show for
# written messages).
display.scroll(string, delay=400)
```

2.1.3 Pins

Provide digital and analog input and output functionality, for the pins in the connector. Some pins are connected internally to the I/O that drives the LED matrix and the buttons.

Each pin is provided as an object directly in the `microbit` module. This keeps the API relatively flat, making it very easy to use:

- `pin0`
- `pin1`
- ...
- `pin15`
- `pin16`
- *Warning: P17-P18 (inclusive) are unavailable.*

- pin19
- pin20

Each of these pins are instances of the `MicroBitPin` class, which offers the following API:

```
# value can be 0, 1, False, True
pin.write_digital(value)
# returns either 1 or 0
pin.read_digital()
# value is between 0 and 1023
pin.write_analog(value)
# returns an integer between 0 and 1023
pin.read_analog()
# sets the period of the PWM output of the pin in milliseconds
# (see https://en.wikipedia.org/wiki/Pulse-width_modulation)
pin.set_analog_period(int)
# sets the period of the PWM output of the pin in microseconds
# (see https://en.wikipedia.org/wiki/Pulse-width_modulation)
pin.set_analog_period_microseconds(int)
# returns boolean
pin.is_touched()
```

2.1.4 Images

Note: You don't always need to create one of these yourself - you can access the image shown on the display directly with `display.image`. `display.image` is just an instance of `Image`, so you can use all of the same methods.

Images API:

```
# creates an empty 5x5 image
image = Image()
# create an image from a string - each character in the string represents an
# LED - 0 (or space) is off and 9 is maximum brightness. The colon ":"
# indicates the end of a line.
image = Image('90009:09090:00900:09090:90009:')
# create an empty image of given size
image = Image(width, height)
# initialises an Image with the specified width and height. The buffer
# should be an array of length width * height
image = Image(width, height, buffer)

# methods
# returns the image's width (most often 5)
image.width()
# returns the image's height (most often 5)
image.height()
# sets the pixel at the specified position (between 0 and 9). May fail for
# constant images.
image.set_pixel(x, y, value)
# gets the pixel at the specified position (between 0 and 9)
image.get_pixel(x, y)
# returns a new image created by shifting the picture left 'n' times.
image.shift_left(n)
# returns a new image created by shifting the picture right 'n' times.
```

(continues on next page)

(continued from previous page)

```

image.shift_right(n)
# returns a new image created by shifting the picture up 'n' times.
image.shift_up(n)
# returns a new image created by shifting the picture down 'n' times.
image.shift_down(n)
# get a compact string representation of the image
repr(image)
# get a more readable string representation of the image
str(image)

#operators
# returns a new image created by superimposing the two images
image + image
# returns a new image created by multiplying the brightness of each pixel by n
image * n

# built-in images.
Image.HEART
Image.HEART_SMALL
Image.HAPPY
Image.SMILE
Image.SAD
Image.CONFUSED
Image.ANGRY
Image.ASLEEP
Image.SURPRISED
Image.SILLY
Image.FABULOUS
Image.MEH
Image.YES
Image.NO
Image.CLOCK12 # clock at 12 o' clock
Image.CLOCK11
... # many clocks (Image.CLOCKn)
Image.CLOCK1 # clock at 1 o'clock
Image.ARROW_N
... # arrows pointing N, NE, E, SE, S, SW, W, NW (microbit.Image.ARROW_direction)
Image.ARROW_NW
Image.TRIANGLE
Image.TRIANGLE_LEFT
Image.CHESSBOARD
Image.DIAMOND
Image.DIAMOND_SMALL
Image.SQUARE
Image.SQUARE_SMALL
Image.RABBIT
Image.COW
Image.MUSIC_CROCHET
Image.MUSIC_QUAVER
Image.MUSIC_QUAVERS
Image.PITCHFORK
Image.XMAS
Image.PACMAN
Image.TARGET
Image.TSHIRT
Image.ROLLERSKATE
Image.DUCK

```

(continues on next page)

(continued from previous page)

```

Image.HOUSE
Image.TORTOISE
Image.BUTTERFLY
Image.STICKFIGURE
Image.GHOST
Image.SWORD
Image.GIRAFFE
Image.SKULL
Image.UMBRELLA
Image.SNAKE
# built-in lists - useful for animations, e.g. display.show(Image.ALL_CLOCKS)
Image.ALL_CLOCKS
Image.ALL_ARROWS

```

2.1.5 The accelerometer

The accelerometer is accessed via the `accelerometer` object:

```

# read the X axis of the device. Measured in milli-g.
accelerometer.get_x()
# read the Y axis of the device. Measured in milli-g.
accelerometer.get_y()
# read the Z axis of the device. Measured in milli-g.
accelerometer.get_z()
# get tuple of all three X, Y and Z readings (listed in that order).
accelerometer.get_values()
# return the name of the current gesture.
accelerometer.current_gesture()
# return True or False to indicate if the named gesture is currently active.
accelerometer.is_gesture(name)
# return True or False to indicate if the named gesture was active since the
# last call.
accelerometer.was_gesture(name)
# return a tuple of the gesture history. The most recent is listed last.
accelerometer.get_gestures()

```

The recognised gestures are: up, down, left, right, face up, face down, freefall, 3g, 6g, 8g, shake.

2.1.6 The compass

The compass is accessed via the `compass` object:

```

# calibrate the compass (this is needed to get accurate readings).
compass.calibrate()
# return a numeric indication of degrees offset from "north".
compass.heading()
# return an numeric indication of the strength of magnetic field around
# the micro:bit.
compass.get_field_strength()
# returns True or False to indicate if the compass is calibrated.
compass.is_calibrated()
# resets the compass to a pre-calibration state.
compass.clear_calibration()

```

2.1.7 I2C bus

There is an I2C bus on the micro:bit that is exposed via the `i2c` object. It has the following methods:

```
# read n bytes from device with addr; repeat=True means a stop bit won't  
# be sent.  
i2c.read(addr, n, repeat=False)  
# write buf to device with addr; repeat=True means a stop bit won't be sent.  
i2c.write(addr, buf, repeat=False)
```

2.1.8 UART

Use `uart` to communicate with a serial device connected to the device's I/O pins:

```
# set up communication (use pins 0 [TX] and 1 [RX]) with a baud rate of 9600.  
uart.init()  
# return True or False to indicate if there are incoming characters waiting to  
# be read.  
uart.any()  
# return (read) n incoming characters.  
uart.read(n)  
# return (read) as much incoming data as possible.  
uart.read()  
# return (read) all the characters to a newline character is reached.  
uart.readline()  
# read bytes into the referenced buffer.  
uart.readinto(buffer)  
# write bytes from the buffer to the connected device.  
uart.write(buffer)
```

The `microbit` module gives you access to all the hardware that is built-in into your board.

3.1 Functions

`microbit.panic(n)`

Enter a panic mode. Requires restart. Pass in an arbitrary integer ≤ 255 to indicate a status:

```
microbit.panic(255)
```

`microbit.reset()`

Restart the board.

`microbit.sleep(n)`

Wait for *n* milliseconds. One second is 1000 milliseconds, so:

```
microbit.sleep(1000)
```

will pause the execution for one second. *n* can be an integer or a floating point number.

`microbit.running_time()`

Return the number of milliseconds since the board was switched on or restarted.

`microbit.temperature()`

Return the temperature of the micro:bit in degrees Celcius.

3.2 Attributes

3.2.1 Buttons

There are two buttons on the board, called `button_a` and `button_b`.

Attributes

`button_a`

A `Button` instance (see below) representing the left button.

`button_b`

Represents the right button.

Classes

`class Button`

Represents a button.

Note: This class is not actually available to the user, it is only used by the two button instances, which are provided already initialized.

`is_pressed()`

Returns `True` if the specified button `button` is currently being held down, and `False` otherwise.

`was_pressed()`

Returns `True` or `False` to indicate if the button was pressed (went from up to down) since the device started or the last time this method was called. Calling this method will clear the press state so that the button must be pressed again before this method will return `True` again.

`get_presses()`

Returns the running total of button presses, and resets this total to zero before returning.

Example

```
import microbit

while True:
    if microbit.button_a.is_pressed() and microbit.button_b.is_pressed():
        microbit.display.scroll("AB")
        break
    elif microbit.button_a.is_pressed():
        microbit.display.scroll("A")
    elif microbit.button_b.is_pressed():
        microbit.display.scroll("B")
    microbit.sleep(100)
```

3.2.2 Input/Output Pins

The pins are your board's way to communicate with external devices connected to it. There are 19 pins for your disposal, numbered 0-16 and 19-20. Pins 17 and 18 are not available.

For example, the script below will change the display on the micro:bit depending upon the digital reading on pin 0:

```
from microbit import *

while True:
    if pin0.read_digital():
```

(continues on next page)

(continued from previous page)

```

display.show(Image.HAPPY)
else:
display.show(Image.SAD)

```

Pin Functions

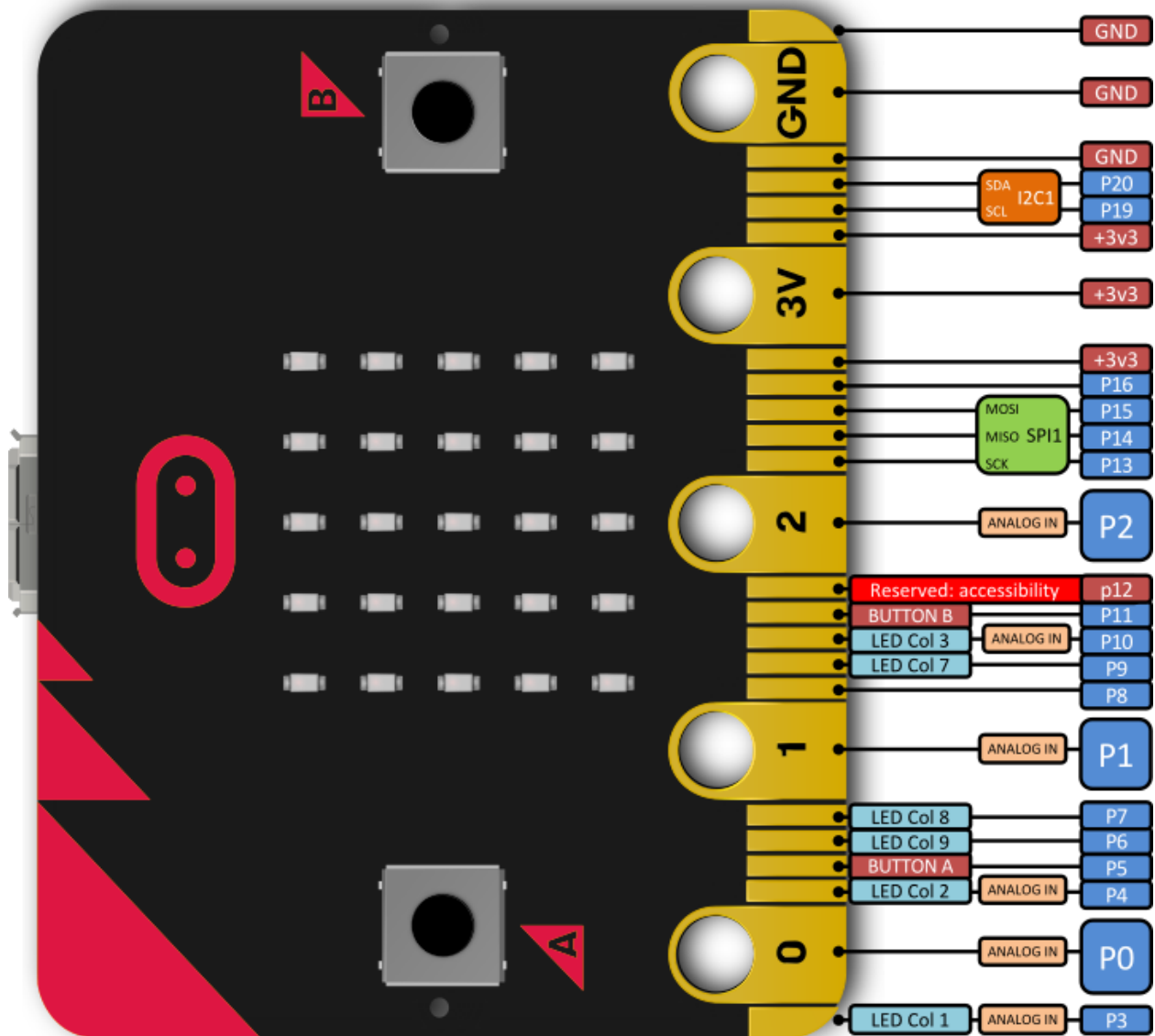

Those pins are available as attributes on the `microbit` module: `microbit.pin0` - `microbit.pin20`.

Pin	Type	Function
0	Touch	Pad 0
1	Touch	Pad 1
2	Touch	Pad 2
3	Analog	Column 1
4	Analog	Column 2
5	Digital	Button A
6	Digital	Column 9
7	Digital	Column 8
8	Digital	
9	Digital	Column 7
10	Analog	Column 3
11	Digital	Button B
12	Digital	
13	Digital	SPI SCK
14	Digital	SPI MISO
15	Digital	SPI MOSI
16	Digital	
19	Digital	I2C SCL
20	Digital	I2C SDA

The above table summarizes the pins available, their types (see below) and what they are internally connected to.

Pulse-Width Modulation

The pins of your board cannot output analog signal the way an audio amplifier can do it – by modulating the voltage on the pin. Those pins can only either enable the full 3.3V output, or pull it down to 0V. However, it is still possible to control the brightness of LEDs or speed of an electric motor, by switching that voltage on and off very fast, and controlling how long it is on and how long it is off. This technique is called Pulse-Width Modulation (PWM), and that's what the `write_analog` method below does.

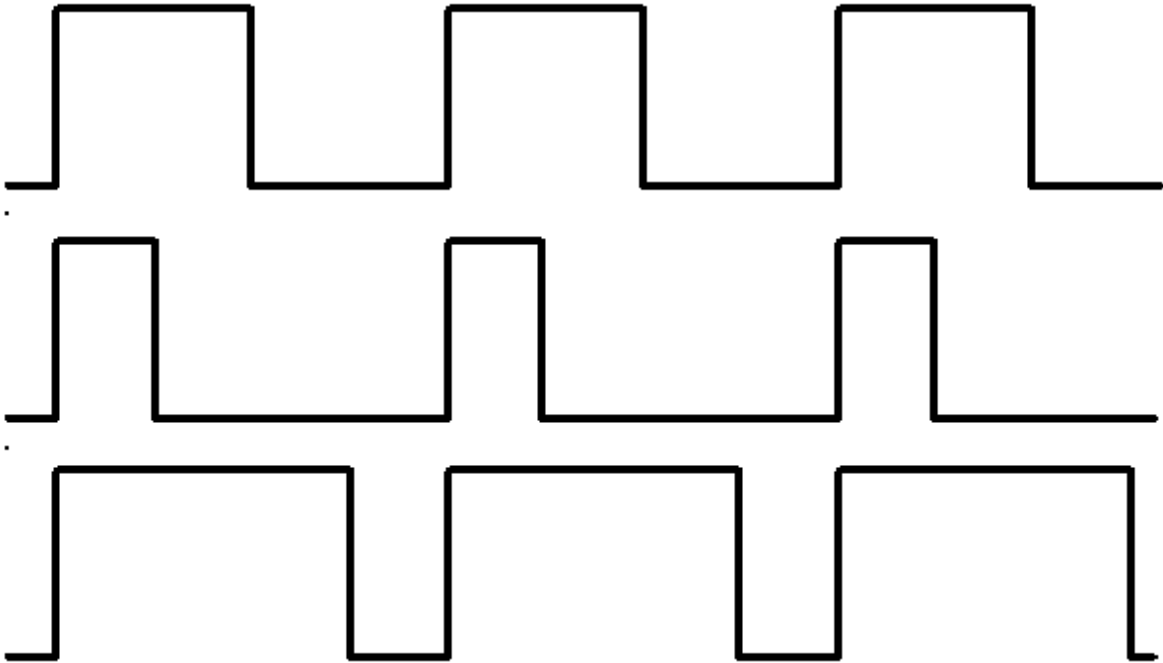

Above you can see the diagrams of three different PWM signals. All of them have the same period (and thus frequency), but they have different duty cycles.

The first one would be generated by `write_analog(511)`, as it has exactly 50% duty – the power is on half of the time, and off half of the time. The result of that is that the total energy of this signal is the same, as if it was 1.65V instead of 3.3V.

The second signal has 25% duty cycle, and could be generated with `write_analog(255)`. It has similar effect as if 0.825V was being output on that pin.

The third signal has 75% duty cycle, and can be generated with `write_analog(767)`. It has three times as much energy, as the second signal, and is equivalent to outputting 2.475V on the pin.

Note that this works well with devices such as motors, which have huge inertia by themselves, or LEDs, which blink too fast for the human eye to see the difference, but will not work so good with generating sound waves. This board can only generate square wave sounds on itself, which sound pretty much like the very old computer games – mostly because those games also only could do that.

Classes

There are three kinds of pins, differing in what is available for them. They are represented by the classes listed below. Note that they form a hierarchy, so that each class has all the functionality of the previous class, and adds its own to that.

Note: Those classes are not actually available for the user, you can't create new instances of them. You can only use the instances already provided, representing the physical pins on your board.

```
class microbit.MicroBitDigitalPin
```

read_digital ()

Return 1 if the pin is high, and 0 if it's low.

write_digital (value)

Set the pin to high if *value* is 1, or to low, if it is 0.

class `microbit.MicroBitAnalogDigitalPin`

read_analog ()

Read the voltage applied to the pin, and return it as an integer between 0 (meaning 0V) and 1023 (meaning 3.3V).

write_analog (value)

Output a PWM signal on the pin, with the duty cycle proportional to the provided *value*. The *value* may be either an integer or a floating point number between 0 (0% duty cycle) and 1023 (100% duty).

set_analog_period (period)

Set the period of the PWM signal being output to *period* in milliseconds. The minimum valid value is 1ms.

set_analog_period_microseconds (period)

Set the period of the PWM signal being output to *period* in microseconds. The minimum valid value is 256µs.

class `microbit.MicroBitAnalogDigitalPin`

read_analog ()

Read the voltage applied to the pin, and return it as an integer between 0 (meaning 0V) and 1023 (meaning 3.3V).

class `microbit.MicroBitTouchPin`

is_touched ()

Return `True` if the pin is being touched with a finger, otherwise return `False`.

This test is done by measuring how much resistance there is between the pin and ground. A low resistance gives a reading of `True`. To get a reliable reading using a finger you may need to touch the ground pin with another part of your body, for example your other hand.

The pull mode for a pin is automatically configured when the pin changes to an input mode. Input modes are when you call `read_analog / read_digital / is_touched`. The default pull mode for these is, respectively, `NO_PULL`, `PULL_DOWN`, `PULL_UP`. Calling `set_pull` will configure the pin to be in `read_digital` mode with the given pull mode.

Note: The micro:bit has external weak (10M) pull-ups fitted on pins 0, 1 and 2 only, in order for the touch sensing to work.

There are also external (10k) pull-ups fitted on pins 5 and 11, in order for buttons A and B to work.

GPIO pins are also used for the display. 6 of these are routed to the edge connector at 3, 4, 6, 7, 9. and 10. If you want to use these pins for another purpose, you may need to turn the [display off](#).

See the [edge connector data sheet](#).

3.3 Classes

3.3.1 Image

The `Image` class is used to create images that can be displayed easily on the device's LED matrix. Given an image object it's possible to display it via the `display` API:

```
display.show(Image.HAPPY)
```

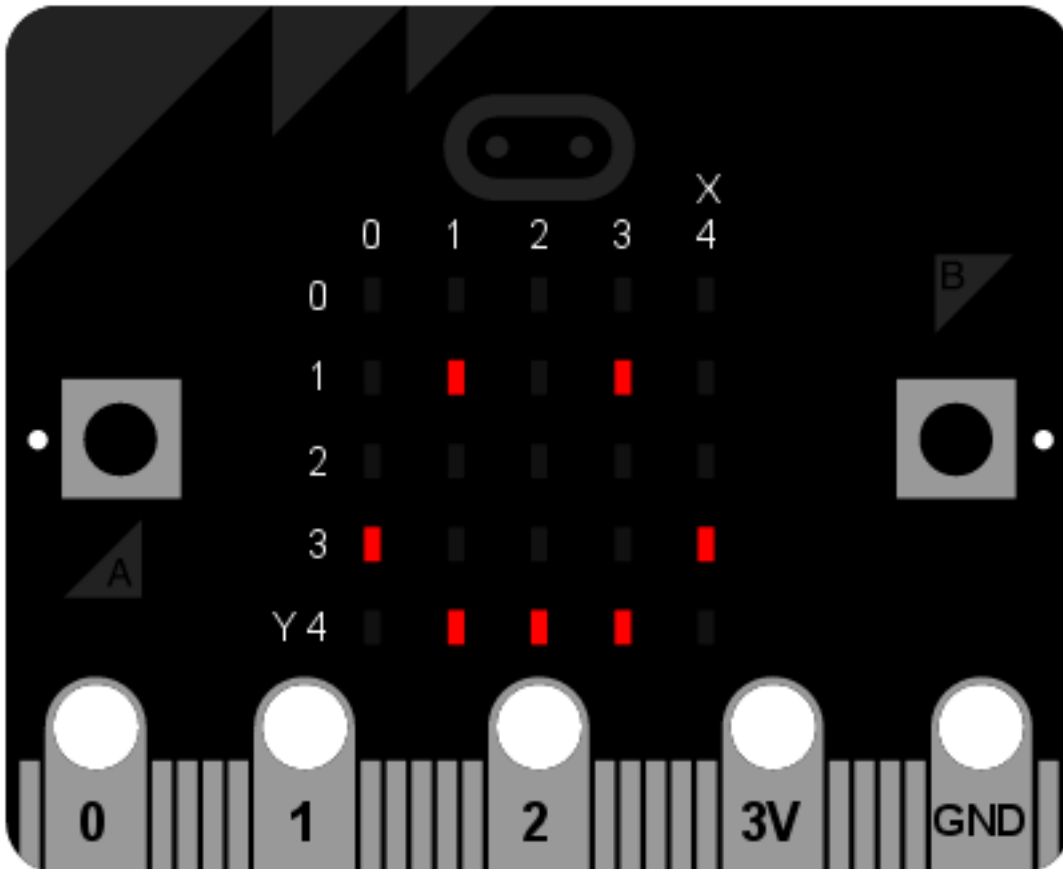

There are four ways in which you can construct an image:

- `Image()` - Create a blank 5x5 image
- `Image(string)` - Create an image by parsing the string, a single character returns that glyph
- `Image(width, height)` - Create a blank image of given size
- `Image(width, height, buffer)` - Create an image from the given buffer

Classes

```
class microbit.Image (string)
```

```
class microbit.Image (width=None, height=None, buffer=None)
```

If `string` is used, it has to consist of digits 0-9 arranged into lines, describing the image, for example:

```
image = Image("90009:"  
              "09090:"  
              "00900:"  
              "09090:"  
              "90009")
```

will create a 5x5 image of an X. The end of a line is indicated by a colon. It's also possible to use a newline (`\n`) to indicate the end of a line like this:

```
image = Image("90009\n"  
              "09090\n"  
              "00900\n"  
              "09090\n"  
              "90009")
```

The other form creates an empty image with `width` columns and `height` rows. Optionally `buffer` can be an array of `width`x`height` integers in range 0-9 to initialize the image:

```
Image(2, 2, b'\x08\x08\x08\x08')
```

or:

```
Image(2, 2, bytearray([9,9,9,9]))
```

Will create a 2 x 2 pixel image at full brightness.

Note: Keyword arguments cannot be passed to `buffer`.

width()

Return the number of columns in the image.

height()

Return the numbers of rows in the image.

set_pixel(x, y, value)

Set the brightness of the pixel at column `x` and row `y` to the `value`, which has to be between 0 (dark) and 9 (bright).

This method will raise an exception when called on any of the built-in read-only images, like `Image.HEART`.

get_pixel(x, y)

Return the brightness of pixel at column `x` and row `y` as an integer between 0 and 9.

shift_left(n)

Return a new image created by shifting the picture left by `n` columns.

shift_right(n)

Same as `image.shift_left(-n)`.

shift_up(n)

Return a new image created by shifting the picture up by `n` rows.

shift_down(n)

Same as `image.shift_up(-n)`.

crop(x, y, w, h)

Return a new image by cropping the picture to a width of `w` and a height of `h`, starting with the pixel at column `x` and row `y`.

copy()

Return an exact copy of the image.

invert()

Return a new image by inverting the brightness of the pixels in the source image.

fill(value)

Set the brightness of all the pixels in the image to the `value`, which has to be between 0 (dark) and 9 (bright).

This method will raise an exception when called on any of the built-in read-only images, like `Image.HEART`.

blit(src, x, y, w, h, xdest=0, ydest=0)

Copy the rectangle defined by `x, y, w, h` from the image `src` into this image at `xdest, ydest`. Areas in the source rectangle, but outside the source image are treated as having a value of 0.

`shift_left()`, `shift_right()`, `shift_up()`, `shift_down()` and `crop()` can all be implemented by using `blit()`. For example, `img.crop(x, y, w, h)` can be implemented as:

```
def crop(self, x, y, w, h):
    res = Image(w, h)
    res.blit(self, x, y, w, h)
    return res
```

Attributes

The `Image` class also has the following built-in instances of itself included as its attributes (the attribute names indicate what the image represents):

- `Image.HEART`
- `Image.HEART_SMALL`
- `Image.HAPPY`
- `Image.SMILE`
- `Image.SAD`
- `Image.CONFUSED`
- `Image.ANGRY`
- `Image.ASLEEP`
- `Image.SURPRISED`
- `Image.SILLY`
- `Image.FABULOUS`
- `Image.MEH`
- `Image.YES`
- `Image.NO`
- `Image.CLOCK12`, `Image.CLOCK11`, `Image.CLOCK10`, `Image.CLOCK9`, `Image.CLOCK8`, `Image.CLOCK7`, `Image.CLOCK6`, `Image.CLOCK5`, `Image.CLOCK4`, `Image.CLOCK3`, `Image.CLOCK2`, `Image.CLOCK1`
- `Image.ARROW_N`, `Image.ARROW_NE`, `Image.ARROW_E`, `Image.ARROW_SE`, `Image.ARROW_S`, `Image.ARROW_SW`, `Image.ARROW_W`, `Image.ARROW_NW`

- `Image.TRIANGLE`
- `Image.TRIANGLE_LEFT`
- `Image.CHESSBOARD`
- `Image.DIAMOND`
- `Image.DIAMOND_SMALL`
- `Image.SQUARE`
- `Image.SQUARE_SMALL`
- `Image.RABBIT`
- `Image.COW`
- `Image.MUSIC_CROTCHET`
- `Image.MUSIC_QUAVER`
- `Image.MUSIC_QUAVERS`
- `Image.PITCHFORK`
- `Image.XMAS`
- `Image.PACMAN`
- `Image.TARGET`
- `Image.TSHIRT`
- `Image.ROLLERSKATE`
- `Image.DUCK`
- `Image.HOUSE`
- `Image.TORTOISE`
- `Image.BUTTERFLY`
- `Image.STICKFIGURE`
- `Image.GHOST`
- `Image.SWORD`
- `Image.GIRAFFE`
- `Image.SKULL`
- `Image.UMBRELLA`
- `Image.SNAKE`

Finally, related collections of images have been grouped together:

```
* ``Image.ALL_CLOCKS``  
* ``Image.ALL_ARROWS``
```

Operations

```
repr(image)
```

Get a compact string representation of the image.

```
str(image)
```

Get a readable string representation of the image.

```
image1 + image2
```

Create a new image by adding the brightness values from the two images for each pixel.

```
image * n
```

Create a new image by multiplying the brightness of each pixel by n.

3.4 Modules

3.4.1 Display

This module controls the 5x5 LED display on the front of your board. It can be used to display images, animations and even text.

Functions

```
microbit.display.get_pixel(x, y)
```

Return the brightness of the LED at column *x* and row *y* as an integer between 0 (off) and 9 (bright).

```
microbit.display.set_pixel(x, y, value)
```

Set the brightness of the LED at column *x* and row *y* to *value*, which has to be an integer between 0 and 9.

```
microbit.display.clear()
```

Set the brightness of all LEDs to 0 (off).

```
microbit.display.show(image)
```

Display the image.

```
microbit.display.show(value, delay=400, *, wait=True, loop=False, clear=False)
```

If *value* is a string, float or integer, display letters/digits in sequence. Otherwise, if *value* is an iterable sequence of images, display these images in sequence. Each letter, digit or image is shown with *delay* milliseconds between them.

If *wait* is `True`, this function will block until the animation is finished, otherwise the animation will happen in the background.

If *loop* is `True`, the animation will repeat forever.

If *clear* is `True`, the display will be cleared after the iterable has finished.

Note that the *wait*, *loop* and *clear* arguments must be specified using their keyword.

Note: If using a generator as the *iterable*, then take care not to allocate any memory in the generator as allocating memory in an interrupt is prohibited and will raise a `MemoryError`.

`microbit.display.scroll(value, delay=150, *, wait=True, loop=False, monospace=False)`

Scrolls `value` horizontally on the display. If `value` is an integer or float it is first converted to a string using `str()`. The `delay` parameter controls how fast the text is scrolling.

If `wait` is `True`, this function will block until the animation is finished, otherwise the animation will happen in the background.

If `loop` is `True`, the animation will repeat forever.

If `monospace` is `True`, the characters will all take up 5 pixel-columns in width, otherwise there will be exactly 1 blank pixel-column between each character as they scroll.

Note that the `wait`, `loop` and `monospace` arguments must be specified using their keyword.

`microbit.display.on()`

Use `on()` to turn on the display.

`microbit.display.off()`

Use `off()` to turn off the display (thus allowing you to re-use the GPIO pins associated with the display for other purposes).

`microbit.display.is_on()`

Returns `True` if the display is on, otherwise returns `False`.

`microbit.display.read_light_level()`

Use the display's LEDs in reverse-bias mode to sense the amount of light falling on the display. Returns an integer between 0 and 255 representing the light level, with larger meaning more light.

Example

To continuously scroll a string across the display, and do it in the background, you can use:

```
import microbit

microbit.display.scroll('Hello!', wait=False, loop=True)
```

3.4.2 UART

The `uart` module lets you talk to a device connected to your board using a serial interface.

Functions

`microbit.uart.init(baudrate=9600, bits=8, parity=None, stop=1, *, tx=None, rx=None)`

Initialize serial communication with the specified parameters on the specified `tx` and `rx` pins. Note that for correct communication, the parameters have to be the same on both communicating devices.

Warning: Initializing the UART on external pins will cause the Python console on USB to become unaccessible, as it uses the same hardware. To bring the console back you must reinitialize the UART without passing anything for `tx` or `rx` (or passing `None` to these arguments). This means that calling `uart.init(115200)` is enough to restore the Python console.

The `baudrate` defines the speed of communication. Common baud rates include:

- 9600

- 14400
- 19200
- 28800
- 38400
- 57600
- 115200

The `bits` defines the size of bytes being transmitted, and the board only supports 8. The `parity` parameter defines how parity is checked, and it can be `None`, `microbit.uart.ODD` or `microbit.uart.EVEN`. The `stop` parameter tells the number of stop bits, and has to be 1 for this board.

If `tx` and `rx` are not specified then the internal USB-UART TX/RX pins are used which connect to the USB serial converter on the micro:bit, thus connecting the UART to your PC. You can specify any other pins you want by passing the desired pin objects to the `tx` and `rx` parameters.

Note: When connecting the device, make sure you “cross” the wires – the TX pin on your board needs to be connected with the RX pin on the device, and the RX pin – with the TX pin on the device. Also make sure the ground pins of both devices are connected.

`uart.any()`

Return `True` if any data is waiting, else `False`.

`uart.read([nbytes])`

Read bytes. If `nbytes` is specified then read at most that many bytes, otherwise read as many bytes as possible.

Return value: a bytes object or `None` on timeout.

A bytes object contains a sequence of bytes. Because [ASCII](#) characters can fit in single bytes this type of object is often used to represent simple text and offers methods to manipulate it as such, e.g. you can display the text using the `print()` function.

You can also convert this object into a string object, and if there are non-ASCII characters present the encoding can be specified:

```
msg_bytes = uart.read()
msg_str = str(msg, 'UTF-8')
```

Note: The timeout for all UART reads depends on the baudrate and is otherwise not changeable via Python. The timeout, in milliseconds, is given by: `microbit_uart_timeout_char = 13000 / baudrate + 1`

Note: The internal UART RX buffer is 64 bytes, so make sure data is read before the buffer is full or some of the data might be lost.

Warning: Receiving `0x03` will stop your program by raising a Keyboard Interrupt. You can enable or disable this using `micropython.kbd_intr()`.

`uart.readall()`

Removed since version 1.0.

Instead, use `uart.read()` with no arguments, which will read as much data as possible.

`uart.readinto(buf[, nbytes])`

Read bytes into the `buf`. If `nbytes` is specified then read at most that many bytes. Otherwise, read at most `len(buf)` bytes.

Return value: number of bytes read and stored into `buf` or `None` on timeout.

`uart.readline()`

Read a line, ending in a newline character.

Return value: the line read or `None` on timeout. The newline character is included in the returned bytes.

`uart.write(buf)`

Write the buffer to the bus, it can be a bytes object or a string:

```
uart.write('hello world')
uart.write(b'hello world')
uart.write(bytes([1, 2, 3]))
```

Return value: number of bytes written or `None` on timeout.

3.4.3 SPI

The `spi` module lets you talk to a device connected to your board using a serial peripheral interface (SPI) bus. SPI uses a so-called master-slave architecture with a single master. You will need to specify the connections for three signals:

- SCLK : Serial Clock (output from master).
- MOSI : Master Output, Slave Input (output from master).
- MISO : Master Input, Slave Output (output from slave).

Functions

`microbit.spi.init(baudrate=1000000, bits=8, mode=0, sclk=pin13, mosi=pin15, miso=pin14)`

Initialize SPI communication with the specified parameters on the specified `pins`. Note that for correct communication, the parameters have to be the same on both communicating devices.

The `baudrate` defines the speed of communication.

The `bits` defines the size of bytes being transmitted. Currently only `bits=8` is supported. However, this may change in the future.

The `mode` determines the combination of clock polarity and phase according to the following convention, with polarity as the high order bit and phase as the low order bit:

SPI Mode	Polarity (CPOL)	Phase (CPHA)
0	0	0
1	0	1
2	1	0
3	1	1

Polarity (aka CPOL) 0 means that the clock is at logic value 0 when idle and goes high (logic value 1) when active; polarity 1 means the clock is at logic value 1 when idle and goes low (logic value 0) when active. Phase (aka CPHA) 0 means that data is sampled on the leading edge of the clock, and 1 means on the trailing edge (viz. https://en.wikipedia.org/wiki/Signal_edge).

The `sclk`, `mosi` and `miso` arguments specify the pins to use for each type of signal.

`spi.read(nbytes)`

Read at most `nbytes`. Returns what was read.

`spi.write(buffer)`

Write the `buffer` of bytes to the bus.

`spi.write_readinto(out, in)`

Write the `out` buffer to the bus and read any response into the `in` buffer. The length of the buffers should be the same. The buffers can be the same object.

3.4.4 I²C

The `i2c` module lets you communicate with devices connected to your board using the I²C bus protocol. There can be multiple slave devices connected at the same time, and each one has its own unique address, that is either fixed for the device or configured on it. Your board acts as the I²C master.

We use 7-bit addressing for devices because of the reasons stated [here](#).

This may be different to other micro:bit related solutions.

How exactly you should communicate with the devices, that is, what bytes to send and how to interpret the responses, depends on the device in question and should be described separately in that device's documentation.

Functions

`microbit.i2c.init(freq=100000, sda=pin20, scl=pin19)`

Re-initialize peripheral with the specified clock frequency `freq` on the specified `sda` and `scl` pins.

Warning: Changing the I²C pins from defaults will make the accelerometer and compass stop working, as they are connected internally to those pins.

`microbit.i2c.scan()`

Scan the bus for devices. Returns a list of 7-bit addresses corresponding to those devices that responded to the scan.

`microbit.i2c.read(addr, n, repeat=False)`

Read `n` bytes from the device with 7-bit address `addr`. If `repeat` is `True`, no stop bit will be sent.

`microbit.i2c.write(addr, buf, repeat=False)`

Write bytes from `buf` to the device with 7-bit address `addr`. If `repeat` is `True`, no stop bit will be sent.

Connecting

You should connect the device's SCL pin to micro:bit pin 19, and the device's SDA pin to micro:bit pin 20. You also must connect the device's ground to the micro:bit ground (pin GND). You may need to power the device using an external power supply or the micro:bit.

There are internal pull-up resistors on the I²C lines of the board, but with particularly long wires or large number of devices you may need to add additional pull-up resistors, to ensure noise-free communication.

3.4.5 Accelerometer

This object gives you access to the on-board accelerometer. The accelerometer also provides convenience functions for detecting gestures. The recognised gestures are: up, down, left, right, face up, face down, freefall, 3g, 6g, 8g, shake.

By default MicroPython sets the accelerometer range to +/- 2g, changing the accelerometer range is currently not possible in MicroPython. The accelerometer returns a value in the range 0..1024 for each axis, which is then scaled accordingly.

Functions

`microbit.accelerometer.get_x()`

Get the acceleration measurement in the x axis, as a positive or negative integer, depending on the direction. The measurement is given in milli-g. By default the accelerometer is configured with a range of +/- 2g, and so this method will return within the range of +/- 2000mg.

`microbit.accelerometer.get_y()`

Get the acceleration measurement in the y axis, as a positive or negative integer, depending on the direction. The measurement is given in milli-g. By default the accelerometer is configured with a range of +/- 2g, and so this method will return within the range of +/- 2000mg.

`microbit.accelerometer.get_z()`

Get the acceleration measurement in the z axis, as a positive or negative integer, depending on the direction. The measurement is given in milli-g. By default the accelerometer is configured with a range of +/- 2g, and so this method will return within the range of +/- 2000mg.

`microbit.accelerometer.get_values()`

Get the acceleration measurements in all axes at once, as a three-element tuple of integers ordered as X, Y, Z. By default the accelerometer is configured with a range of +/- 2g, and so X, Y, and Z will be within the range of +/-2000mg.

`microbit.accelerometer.current_gesture()`

Return the name of the current gesture.

Note: MicroPython understands the following gesture names: "up", "down", "left", "right", "face up", "face down", "freefall", "3g", "6g", "8g", "shake". Gestures are always represented as strings.

`microbit.accelerometer.is_gesture(name)`

Return True or False to indicate if the named gesture is currently active.

`microbit.accelerometer.was_gesture(name)`

Return True or False to indicate if the named gesture was active since the last call.

`microbit.accelerometer.get_gestures()`

Return a tuple of the gesture history. The most recent is listed last. Also clears the gesture history before returning.

Note: Gestures are not updated in the background so there needs to be constant calls to some accelerometer method to do the gesture detection. Usually gestures can be detected using a loop with a small `microbit.sleep()` delay.

Examples

A fortune telling magic 8-ball. Ask a question then shake the device for an answer.

```
# Magic 8 ball by Nicholas Tollervey. February 2016.
#
# Ask a question then shake.
#
# This program has been placed into the public domain.
from microbit import *
import random

answers = [
    "It is certain",
    "It is decidedly so",
    "Without a doubt",
    "Yes, definitely",
    "You may rely on it",
    "As I see it, yes",
    "Most likely",
    "Outlook good",
    "Yes",
    "Signs point to yes",
    "Reply hazy try again",
    "Ask again later",
    "Better not tell you now",
    "Cannot predict now",
    "Concentrate and ask again",
    "Don't count on it",
    "My reply is no",
    "My sources say no",
    "Outlook not so good",
    "Very doubtful",
]

while True:
    display.show('8')
    if accelerometer.was_gesture('shake'):
        display.clear()
        sleep(1000)
        display.scroll(random.choice(answers))
    sleep(10)
```

Simple Slalom. Move the device to avoid the obstacles.

```
# Simple Slalom by Larry Hastings, September 2015
#
# This program has been placed into the public domain.

import microbit as m
import random

p = m.display.show

min_x = -1024
max_x = 1024
range_x = max_x - min_x
```

(continues on next page)

(continued from previous page)

```

wall_min_speed = 400
player_min_speed = 200

wall_max_speed = 100
player_max_speed = 50

speed_max = 12

while True:

    i = m.Image('00000:'*5)
    s = i.set_pixel

    player_x = 2

    wall_y = -1
    hole = 0

    score = 0
    handled_this_wall = False

    wall_speed = wall_min_speed
    player_speed = player_min_speed

    wall_next = 0
    player_next = 0

    while True:
        t = m.running_time()
        player_update = t >= player_next
        wall_update = t >= wall_next
        if not (player_update or wall_update):
            next_event = min(wall_next, player_next)
            delta = next_event - t
            m.sleep(delta)
            continue

        if wall_update:
            # calculate new speeds
            speed = min(score, speed_max)
            wall_speed = wall_min_speed + int((wall_max_speed - wall_min_speed) *
↪speed / speed_max)
            player_speed = player_min_speed + int((player_max_speed - player_min_
↪speed) * speed / speed_max)

            wall_next = t + wall_speed
            if wall_y < 5:
                # erase old wall
                use_wall_y = max(wall_y, 0)
                for wall_x in range(5):
                    if wall_x != hole:
                        s(wall_x, use_wall_y, 0)

            wall_reached_player = (wall_y == 4)
            if player_update:

```

(continues on next page)

(continued from previous page)

```

player_next = t + player_speed
# find new x coord
x = m.accelerometer.get_x()
x = min(max(min_x, x), max_x)
# print("x accel", x)
s(player_x, 4, 0) # turn off old pixel
x = ((x - min_x) / range_x) * 5
x = min(max(0, x), 4)
x = int(x + 0.5)
# print("have", position, "want", x)

if not handled_this_wall:
    if player_x < x:
        player_x += 1
    elif player_x > x:
        player_x -= 1
    # print("new", position)
    # print()

if wall_update:
    # update wall position
    wall_y += 1
    if wall_y == 7:
        wall_y = -1
        hole = random.randrange(5)
        handled_this_wall = False

    if wall_y < 5:
        # draw new wall
        use_wall_y = max(wall_y, 0)
        for wall_x in range(5):
            if wall_x != hole:
                s(wall_x, use_wall_y, 6)

if wall_reached_player and not handled_this_wall:
    handled_this_wall = True
    if (player_x != hole):
        # collision! game over!
        break
    score += 1

if player_update:
    s(player_x, 4, 9) # turn on new pixel

p(i)

p(i.SAD)
m.sleep(1000)
m.display.scroll("Score:" + str(score))

while True:
    if (m.button_a.is_pressed() and m.button_a.is_pressed()):
        break
    m.sleep(100)

```

3.4.6 Compass

This module lets you access the built-in electronic compass. Before using, the compass should be calibrated, otherwise the readings may be wrong.

Warning: Calibrating the compass will cause your program to pause until calibration is complete. Calibration consists of a little game to draw a circle on the LED display by rotating the device.

Functions

`microbit.compass.calibrate()`

Starts the calibration process. An instructive message will be scrolled to the user after which they will need to rotate the device in order to draw a circle on the LED display.

`microbit.compass.is_calibrated()`

Returns `True` if the compass has been successfully calibrated, and returns `False` otherwise.

`microbit.compass.clear_calibration()`

Undoes the calibration, making the compass uncalibrated again.

`microbit.compass.get_x()`

Gives the reading of the magnetic field strength on the `x` axis in nano tesla, as a positive or negative integer, depending on the direction of the field.

`microbit.compass.get_y()`

Gives the reading of the magnetic field strength on the `y` axis in nano tesla, as a positive or negative integer, depending on the direction of the field.

`microbit.compass.get_z()`

Gives the reading of the magnetic field strength on the `z` axis in nano tesla, as a positive or negative integer, depending on the direction of the field.

`microbit.compass.heading()`

Gives the compass heading, calculated from the above readings, as an integer in the range from 0 to 360, representing the angle in degrees, clockwise, with north as 0.

`microbit.compass.get_field_strength()`

Returns an integer indication of the magnitude of the magnetic field around the device in nano tesla.

Example

```
"""
    compass.py
    ~~~~~

    Creates a compass.

    The user will need to calibrate the compass first. The compass uses the
    built-in clock images to display the position of the needle.

    """
from microbit import *

# Start calibrating
```

(continues on next page)

(continued from previous page)

```
compass.calibrate()

# Try to keep the needle pointed in (roughly) the correct direction
while True:
    sleep(100)
    needle = ((15 - compass.heading()) // 30) % 12
    display.show(Image.ALL_CLOCKS[needle])
```

This module allows you play sounds from a speaker attached to the Microbit. In order to use the audio module you will need to provide a sound source.

A sound source is an iterable (sequence, like list or tuple, or a generator) of frames, each of 32 samples. The `audio` module plays samples at the rate of 7812.5 samples per second, which means that it can reproduce frequencies up to 3.9kHz.

4.1 Functions

`audio.play` (*source*, *wait=True*, *pin=pin0*, *return_pin=None*)

Play the source to completion.

source is an iterable, each element of which must be an `AudioFrame`.

If *wait* is `True`, this function will block until the source is exhausted.

pin specifies which pin the speaker is connected to.

return_pin specifies a differential pin to connect to the speaker instead of ground.

4.2 Classes

class `audio.AudioFrame`

An `AudioFrame` object is a list of 32 samples each of which is a signed byte (whole number between -128 and 127).

It takes just over 4 ms to play a single frame.

4.3 Using audio

You will need a sound source, as input to the `play` function. You can generate your own, like in `examples/waveforms.py`.

4.4 Technical Details

Note: You don't need to understand this section to use the `audio` module. It is just here in case you wanted to know how it works.

The `audio` module consumes samples at 7812.5 Hz, and uses linear interpolation to output a PWM signal at 32.5 kHz, which gives tolerable sound quality.

The function `play` fully copies all data from each `AudioFrame` before it calls `next()` for the next frame, so a sound source can use the same `AudioFrame` repeatedly.

The `audio` module has an internal 64 sample buffer from which it reads samples. When reading reaches the start or the mid-point of the buffer, it triggers a callback to fetch the next `AudioFrame` which is then copied into the buffer. This means that a sound source has under 4ms to compute the next `AudioFrame`, and for reliable operation needs to take less 2ms (which is 32000 cycles, so should be plenty).

4.5 Example

```
from microbit import display, sleep, button_a
import audio
import math

def repeated_frame(frame, count):
    for i in range(count):
        yield frame

# Press button A to skip to next wave.
def show_wave(name, frame, duration=1500):
    display.scroll(name + " wave", wait=False, delay=100)
    audio.play(repeated_frame(frame, duration), wait=False)
    for i in range(75):
        sleep(100)
        if button_a.is_pressed():
            display.clear()
            audio.stop()
            break

frame = audio.AudioFrame()

for i in range(len(frame)):
    frame[i] = int(math.sin(math.pi*i/16)*124+128.5)
show_wave("Sine", frame)

triangle = audio.AudioFrame()

QUARTER = len(triangle)//4
```

(continues on next page)

(continued from previous page)

```
for i in range(QUARTER):
    triangle[i] = i*15
    triangle[i+QUARTER] = 248-i*15
    triangle[i+QUARTER*2] = 128-i*15
    triangle[i+QUARTER*3] = i*15+8
show_wave("Triangle", triangle)

square = audio.AudioFrame()

HALF = len(square)//2
for i in range(HALF):
    square[i] = 8
    square[i+HALF] = 248
show_wave("Square", square)
sleep(1000)

for i in range(len(frame)):
    frame[i] = 252-i*8
show_wave("Sawtooth", frame)

del frame

#Generate a waveform that goes from triangle to square wave, reasonably smoothly.
frames = [ None ] * 32
for i in range(32):
    frames[i] = frame = audio.AudioFrame()
    for j in range(len(triangle)):
        frame[j] = (triangle[j]*(32-i) + square[j]*i)>>5

def repeated_frames(frames, count):
    for frame in frames:
        for i in range(count):
            yield frame

display.scroll("Ascending wave", wait=False)
audio.play(repeated_frames(frames, 60))
```

CHAPTER 5

Bluetooth

While the BBC micro:bit has hardware capable of allowing the device to work as a Bluetooth Low Energy (BLE) device, it only has 16k of RAM. The BLE stack alone takes up 12k RAM which means there's not enough memory for MicroPython to support Bluetooth.

Note: MicroPython uses the radio hardware with the `radio` module. This allows users to create simple yet effective wireless networks of micro:bit devices.

Furthermore, the protocol used in the `radio` module is a lot simpler than BLE, making it far easier to use in an educational context.

Local Persistent File System

It is useful to store data in a persistent manner so that it remains intact between restarts of the device. On traditional computers this is often achieved by a file system consisting of named files that hold raw data, and named directories that contain files. Python supports the various operations needed to work with such file systems.

However, since the micro:bit is a limited device in terms of both hardware and storage capacity MicroPython provides a small subset of the functions needed to persist data on the device. Because of memory constraints **there is approximately 30k of storage available** on the file system.

Warning: Re-flashing the device will DESTROY YOUR DATA.

Since the file system is stored in the micro:bit's flash memory and flashing the device rewrites all the available flash memory then all your data will be lost if you flash your device.

However, if you switch your device off the data will remain intact until you either delete it (see below) or re-flash the device.

MicroPython on the micro:bit provides a flat file system; i.e. there is no notion of a directory hierarchy, the file system is just a list of named files. Reading and writing a file is achieved via the standard Python `open` function and the resulting file-like object (representing the file) of types `TextIO` or `BytesIO`. Operations for working with files on the file system (for example, listing or deleting files) are contained within the `os` module.

If a file ends in the `.py` file extension then it can be imported. For example, a file named `hello.py` can be imported like this: `import hello`.

An example session in the MicroPython REPL may look something like this:

```
>>> with open('hello.py', 'w') as hello:
...     hello.write("print('Hello')")
...
>>> import hello
Hello
>>> with open('hello.py') as hello:
...     print(hello.read())
```

(continues on next page)

(continued from previous page)

```

...
print('Hello')
>>> import os
>>> os.listdir()
['hello.py']
>>> os.remove('hello.py')
>>> os.listdir()
[]

```

open (*filename*, *mode='r'*)

Returns a file object representing the file named in the argument *filename*. The mode defaults to 'r' which means open for reading in text mode. The other common mode is 'w' for writing (overwriting the content of the file if it already exists). Two other modes are available to be used in conjunction with the ones described above: 't' means text mode (for reading and writing strings) and 'b' means binary mode (for reading and writing bytes). If these are not specified then 't' (text mode) is assumed. When in text mode the file object will be an instance of `TextIO`. When in binary mode the file object will be an instance of `BytesIO`. For example, use 'rb' to read binary data from a file.

class TextIO**class BytesIO**

Instances of these classes represent files in the micro:bit's flat file system. The `TextIO` class is used to represent text files. The `BytesIO` class is used to represent binary files. They work in exactly the same except that `TextIO` works with strings and `BytesIO` works with bytes.

You do not directly instantiate these classes. Rather, an appropriately configured instance of the class is returned by the `open` function described above.

close ()

Flush and close the file. This method has no effect if the file is already closed. Once the file is closed, any operation on the file (e.g. reading or writing) will raise an exception.

name ()

Returns the name of the file the object represents. This will be the same as the *filename* argument passed into the call to the `open` function that instantiated the object.

read (*size*)

Read and return at most *size* characters as a single string or *size* bytes from the file. As a convenience, if *size* is unspecified or -1, all the data contained in the file is returned. Fewer than *size* characters or bytes may be returned if there are less than *size* characters or bytes remaining to be read from the file.

If 0 characters or bytes are returned, and *size* was not 0, this indicates end of file.

A `MemoryError` exception will occur if *size* is larger than the available RAM.

readinto (*buf*, *n=-1*)

Read characters or bytes into the buffer *buf*. If *n* is supplied, read *n* number of bytes or characters into the buffer *buf*.

readline (*size*)

Read and return one line from the file. If *size* is specified, at most *size* characters will be read.

The line terminator is always '\n' for strings or b'\n' for bytes.

writable ()

Return `True` if the file supports writing. If `False`, `write()` will raise `OSError`.

write (*buf*)

Write the string or bytes *buf* to the file and return the number of characters or bytes written.

The machine module contains specific functions related to the micro:bit hardware. Most functions in this module allow to achieve direct and unrestricted access to and control of hardware blocks on a system (like CPU, timers, buses, etc.). Used incorrectly, this can lead to malfunction, lockups, crashes of your board, and in extreme cases, hardware damage.

7.1 Functions

`machine.unique_id()`

Returns a byte string with a unique identifier of a board. It will vary from one board instance to another.

`machine.reset()`

Resets the device in a manner similar to pushing the external RESET button.

`machine.freq()`

Returns CPU frequency in hertz.

`machine.disable_irq()`

Disable interrupt requests. Returns the previous IRQ state which should be considered an opaque value. This return value should be passed to the `machine.enable_irq()` function to restore interrupts to their original state, before `machine.disable_irq()` was called.

`machine.enable_irq()`

Re-enable interrupt requests. The `state` parameter should be the value that was returned from the most recent call to the `machine.disable_irq()` function.

`machine.time_pulse_us(pin, pulse_level, timeout_us=1000000)`

Time a pulse on the given `pin`, and return the duration of the pulse in microseconds. The `pulse_level` argument should be 0 to time a low pulse or 1 to time a high pulse.

If the current input value of the pin is different to `pulse_level`, the function first (*) waits until the pin input becomes equal to `pulse_level`, then (**) times the duration that the pin is equal to `pulse_level`. If the pin is already equal to `pulse_level` then timing starts straight away.

The function will return -2 if there was timeout waiting for condition marked (*) above, and -1 if there was timeout during the main measurement, marked (**) above. The timeout is the same for both cases and given by *timeout_us* (which is in microseconds).

7.2 Reading Memory

The `machine` module allows you to read from the device's memory, getting 1 byte (8 bits; `mem8`), 2 byte (16 bits; `mem16`), or 4 byte (32 bits; `mem32`) words from physical addresses. For example: `mem8[0x00]` reads 1 byte on physical address `0x00`. This has a number of uses, for example if you'd like to read data from the nRF51 registers.

Access and control MicroPython internals.

8.1 Functions

`micropython.const` (*expr*)

Used to declare that the expression is a constant so that the compiler can optimise it. The use of this function should be as follows:

```
from micropython import const
CONST_X = const(123)
CONST_Y = const(2 * CONST_X + 1)
```

Constants declared this way are still accessible as global variables from outside the module they are declared in. On the other hand, if a constant begins with an underscore then it is hidden, it is not available as a global variable, and does not take up any memory during execution.

`micropython.opt_level` (*[level]*)

If *level* is given then this function sets the optimisation level for subsequent compilation of scripts, and returns `None`. Otherwise it returns the current optimisation level.

The optimisation level controls the following compilation features:

- **Assertions:** at level 0 assertion statements are enabled and compiled into the bytecode; at levels 1 and higher assertions are not compiled.
- **Built-in `__debug__` variable:** at level 0 this variable expands to `True`; at levels 1 and higher it expands to `False`.
- **Source-code line numbers:** at levels 0, 1 and 2 source-code line number are stored along with the bytecode so that exceptions can report the line number they occurred at; at levels 3 and higher line numbers are not stored.

The default optimisation level is usually level 0.

`micropython.mem_info(verbose)`

Print information about currently used memory. If the `verbose` argument is given then extra information is printed.

`micropython.qstr_info(verbose)`

Print information about currently interned strings. If the `verbose` argument is given then extra information is printed.

This includes the number of interned strings and the amount of RAM they use. In verbose mode it prints out the names of all RAM-interned strings.

`micropython.stack_use()`

Return an integer representing the current amount of stack that is being used. The absolute value of this is not particularly useful, rather it should be used to compute differences in stack usage at different points.

`micropython.heap_lock()`

`micropython.heap_unlock()`

Lock or unlock the heap. When locked no memory allocation can occur and a `MemoryError` will be raised if any heap allocation is attempted.

`micropython.kbd_intr(chr)`

Set the character that will raise a `KeyboardInterrupt` exception. By default this is set to 3 during script execution, corresponding to Ctrl-C. Passing -1 to this function will disable capture of Ctrl-C, and passing 3 will restore it.

This function can be used to prevent the capturing of Ctrl-C on the incoming stream of characters that is usually used for the REPL, in case that stream is used for other purposes

CHAPTER 9

Music

This is the `music` module. You can use it to play simple tunes, provided that you connect a speaker to your board. By default the `music` module expects the speaker to be connected via pin 0:

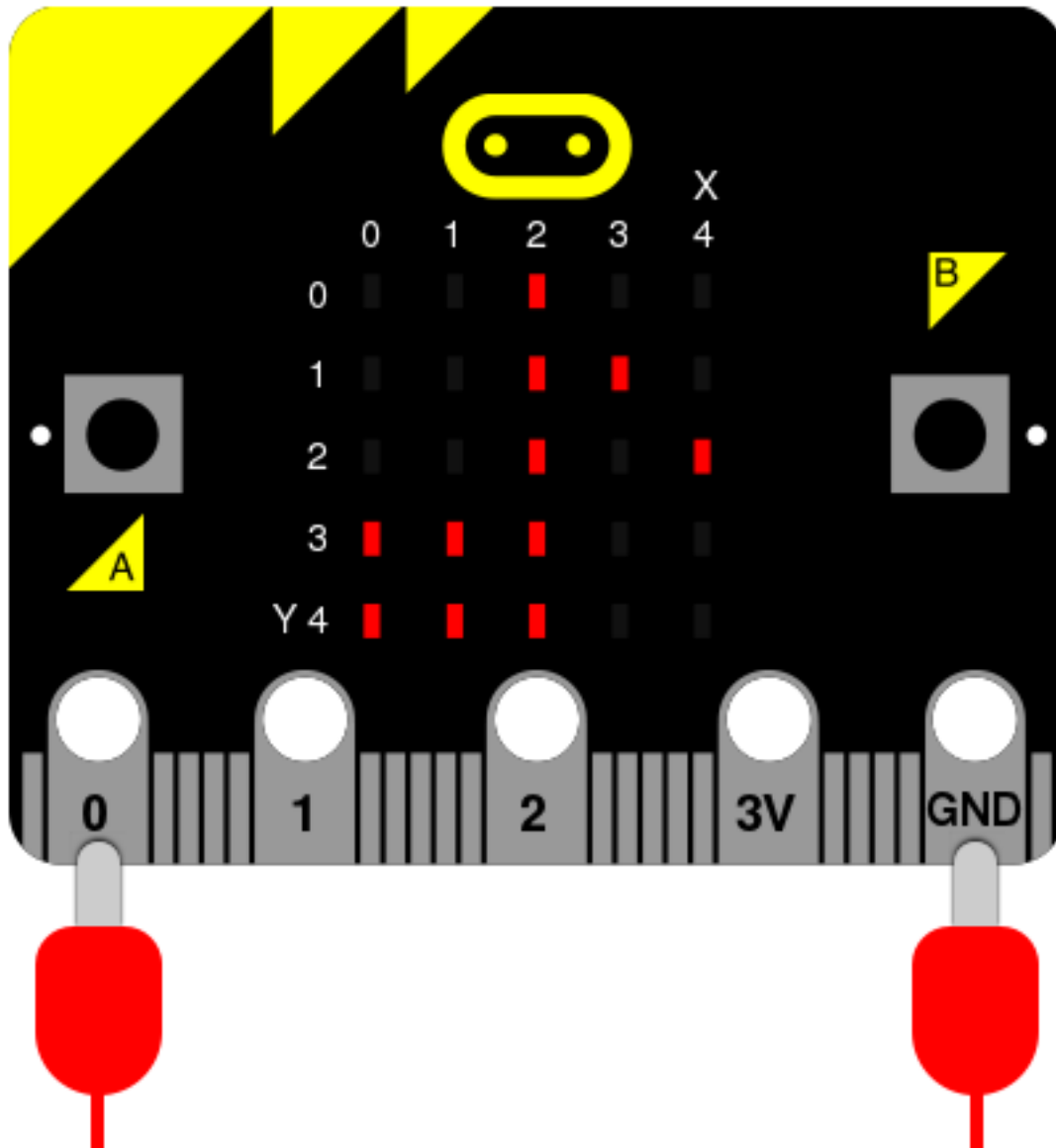

This arrangement can be overridden (as discussed below).

To access this module you need to:

```
import music
```

We assume you have done this for the examples below.

9.1 Musical Notation

An individual note is specified thus:

```
NOTE[octave][:duration]
```

For example, `A1:4` refers to the note “A” in octave 1 that lasts for four ticks (a tick is an arbitrary length of time defined by a tempo setting function - see below). If the note name `R` is used then it is treated as a rest (silence).

Accidentals (flats and sharps) are denoted by the `b` (flat - a lower case b) and `#` (sharp - a hash symbol). For example, `Ab` is A-flat and `C#` is C-sharp.

Note names are case-insensitive.

The `octave` and `duration` parameters are states that carry over to subsequent notes until re-specified. The default states are `octave = 4` (containing middle C) and `duration = 4` (a crotchet, given the default tempo settings - see below).

For example, if 4 ticks is a crotchet, the following list is crotchet, quaver, quaver, crotchet based arpeggio:

```
['c1:4', 'e:2', 'g', 'c2:4']
```

The opening of Beethoven’s 5th Symphony would be encoded thus:

```
['r4:2', 'g', 'g', 'g', 'eb:8', 'r:2', 'f', 'f', 'f', 'd:8']
```

The definition and scope of an octave conforms to the table listed [on this page about scientific pitch notation](#). For example, middle “C” is `'c4'` and concert “A” (440) is `'a4'`. Octaves start on the note “C”.

9.2 Functions

`music.set_tempo(ticks=4, bpm=120)`

Sets the approximate tempo for playback.

A number of ticks (expressed as an integer) constitute a beat. Each beat is to be played at a certain frequency per minute (expressed as the more familiar BPM - beats per minute - also as an integer).

Suggested default values allow the following useful behaviour:

- `music.set_tempo()` - reset the tempo to default of ticks = 4, bpm = 120
- `music.set_tempo(ticks=8)` - change the “definition” of a beat
- `music.set_tempo(bpm=180)` - just change the tempo

To work out the length of a tick in milliseconds is very simple arithmetic: $60000/\text{bpm}/\text{ticks_per_beat}$. For the default values that’s $60000/120/4 = 125$ milliseconds or 1 beat = 500 milliseconds.

`music.get_tempo()`

Gets the current tempo as a tuple of integers: (ticks, bpm).

`music.play(music, pin=microbit.pin0, wait=True, loop=False)`

Plays `music` containing the musical DSL defined above.

If `music` is a string it is expected to be a single note such as, `'c1:4'`.

If `music` is specified as a list of notes (as defined in the section on the musical DSL, above) then they are played one after the other to perform a melody.

In both cases, the `duration` and `octave` values are reset to their defaults before the music (whatever it may be) is played.

An optional argument to specify the output pin can be used to override the default of `microbit.pin0`.

If `wait` is set to `True`, this function is blocking.

If `loop` is set to `True`, the tune repeats until `stop` is called (see below) or the blocking call is interrupted.

`music.pitch` (*frequency*, *duration=-1*, *pin=microbit.pin0*, *wait=True*)

Plays a pitch at the integer frequency given for the specified number of milliseconds. For example, if the frequency is set to 440 and the length to 1000 then we hear a standard concert A for one second.

Note that you can only play one pitch on one pin at any one time.

If `wait` is set to `True`, this function is blocking.

If `duration` is negative the pitch is played continuously until either the blocking call is interrupted or, in the case of a background call, a new frequency is set or `stop` is called (see below).

`music.stop` (*pin=microbit.pin0*)

Stops all music playback on a given pin, eg. `music.stop(pin1)`. If no pin is given, eg. `music.stop()` `pin0` is assumed.

`music.reset` ()

Resets the state of the following attributes in the following way:

- `ticks = 4`
- `bpm = 120`
- `duration = 4`
- `octave = 4`

9.2.1 Built in Melodies

For the purposes of education and entertainment, the module contains several example tunes that are expressed as Python lists. They can be used like this:

```
>>> import music
>>> music.play(music.NYAN)
```

All the tunes are either out of copyright, composed by Nicholas H.Tollervy and released to the public domain or have an unknown composer and are covered by a fair (educational) use provision.

They are:

- DADADADUM - the opening to Beethoven's 5th Symphony in C minor.
- ENTERTAINER - the opening fragment of Scott Joplin's Ragtime classic "The Entertainer".
- PRELUDE - the opening of the first Prelude in C Major of J.S.Bach's 48 Preludes and Fugues.
- ODE - the "Ode to Joy" theme from Beethoven's 9th Symphony in D minor.
- NYAN - the Nyan Cat theme (<http://www.nyan.cat/>). The composer is unknown. This is fair use for educational porpoises (as they say in New York).
- RINGTONE - something that sounds like a mobile phone ringtone. To be used to indicate an incoming message.
- FUNK - a funky bass line for secret agents and criminal masterminds.
- BLUES - a boogie-woogie 12-bar blues walking bass.
- BIRTHDAY - "Happy Birthday to You..." for copyright status see: <http://www.bbc.co.uk/news/world-us-canada-34332853>
- WEDDING - the bridal chorus from Wagner's opera "Lohengrin".
- FUNERAL - the "funeral march" otherwise known as Frédéric Chopin's Piano Sonata No. 2 in B minor, Op. 35.
- PUNCHLINE - a fun fragment that signifies a joke has been made.

- PYTHON - John Philip Sousa's march "Liberty Bell" aka, the theme for "Monty Python's Flying Circus" (after which the Python programming language is named).
- BADDY - silent movie era entrance of a baddy.
- CHASE - silent movie era chase scene.
- BA_DING - a short signal to indicate something has happened.
- WAWAWAWAA - a very sad trombone.
- JUMP_UP - for use in a game, indicating upward movement.
- JUMP_DOWN - for use in a game, indicating downward movement.
- POWER_UP - a fanfare to indicate an achievement unlocked.
- POWER_DOWN - a sad fanfare to indicate an achievement lost.

9.2.2 Example

```

"""
    music.py
    ~~~~~

    Plays a simple tune using the Micropython music module.
    This example requires a speaker/buzzer/headphones connected to P0 and GND.
"""
from microbit import *
import music

# play Prelude in C.
notes = [
    'c4:1', 'e', 'g', 'c5', 'e5', 'g4', 'c5', 'e5', 'c4', 'e', 'g', 'c5', 'e5', 'g4',
    ↪ 'c5', 'e5',
    'c4', 'd', 'a', 'd5', 'f5', 'a4', 'd5', 'f5', 'c4', 'd', 'a', 'd5', 'f5', 'a4',
    ↪ 'd5', 'f5',
    'b3', 'd4', 'g', 'd5', 'f5', 'g4', 'd5', 'f5', 'b3', 'd4', 'g', 'd5', 'f5', 'g4',
    ↪ 'd5', 'f5',
    'c4', 'e', 'g', 'c5', 'e5', 'g4', 'c5', 'e5', 'c4', 'e', 'g', 'c5', 'e5', 'g4',
    ↪ 'c5', 'e5',
    'c4', 'e', 'a', 'e5', 'a5', 'a4', 'e5', 'a5', 'c4', 'e', 'a', 'e5', 'a5', 'a4',
    ↪ 'e5', 'a5',
    'c4', 'd', 'f#', 'a', 'd5', 'f#4', 'a', 'd5', 'c4', 'd', 'f#', 'a', 'd5', 'f#4',
    ↪ 'a', 'd5',
    'b3', 'd4', 'g', 'd5', 'g5', 'g4', 'd5', 'g5', 'b3', 'd4', 'g', 'd5', 'g5', 'g4',
    ↪ 'd5', 'g5',
    'b3', 'c4', 'e', 'g', 'c5', 'e4', 'g', 'c5', 'b3', 'c4', 'e', 'g', 'c5', 'e4', 'g
    ↪ ', 'c5',
    'a3', 'c4', 'e', 'g', 'c5', 'e4', 'g', 'c5', 'a3', 'c4', 'e', 'g', 'c5', 'e4', 'g
    ↪ ', 'c5',
    'd3', 'a', 'd4', 'f#', 'c5', 'd4', 'f#', 'c5', 'd3', 'a', 'd4', 'f#', 'c5', 'd4',
    ↪ 'f#', 'c5',
    'g3', 'b', 'd4', 'g', 'b', 'd', 'g', 'b', 'g3', 'b3', 'd4', 'g', 'b', 'd', 'g', 'b
    ↪ '
]

music.play(notes)

```

CHAPTER 10

NeoPixel

The `neopixel` module lets you use NeoPixel (WS2812) individually addressable RGB LED strips with the micro:bit. Note to use the `neopixel` module, you need to import it separately with:

```
import neopixel
```

Note: From our tests, the Microbit NeoPixel module can drive up to around 256 NeoPixels. Anything above that and you may experience weird bugs and issues. As the micro:bit can only supply 90mA to external devices, larger numbers of NeoPixels require an external power supply with common ground.

NeoPixels are designed to work at 5V, but luckily they still function using the 3V supply of the BBC micro:bit. Please note that the micro:bit edge connector should not be connected to anything supplying 5V.

NeoPixels are fun strips of multi-coloured programmable LEDs. This module contains everything to plug them into a micro:bit and create funky displays, art and games such as the demo shown below.

To connect a strip of neopixels you'll need to attach the micro:bit as shown below (assuming you want to drive the pixels from pin 0 - you can connect neopixels to pins 1 and 2 too). The label on the crocodile clip tells you where to attach the other end on the neopixel strip. The VDD pin may be labelled as something else on some variants of neopixels - for example "V+". In some cases it may be called "+5V" and it is only safe to use this if you have no other 5V devices connected.

Warning: Do not use the 3v connector on the Microbit to power any more than 8 Neopixels at a time.

If you wish to use more than 8 Neopixels, you must use a separate 3v-5v power supply for the Neopixel power pin.

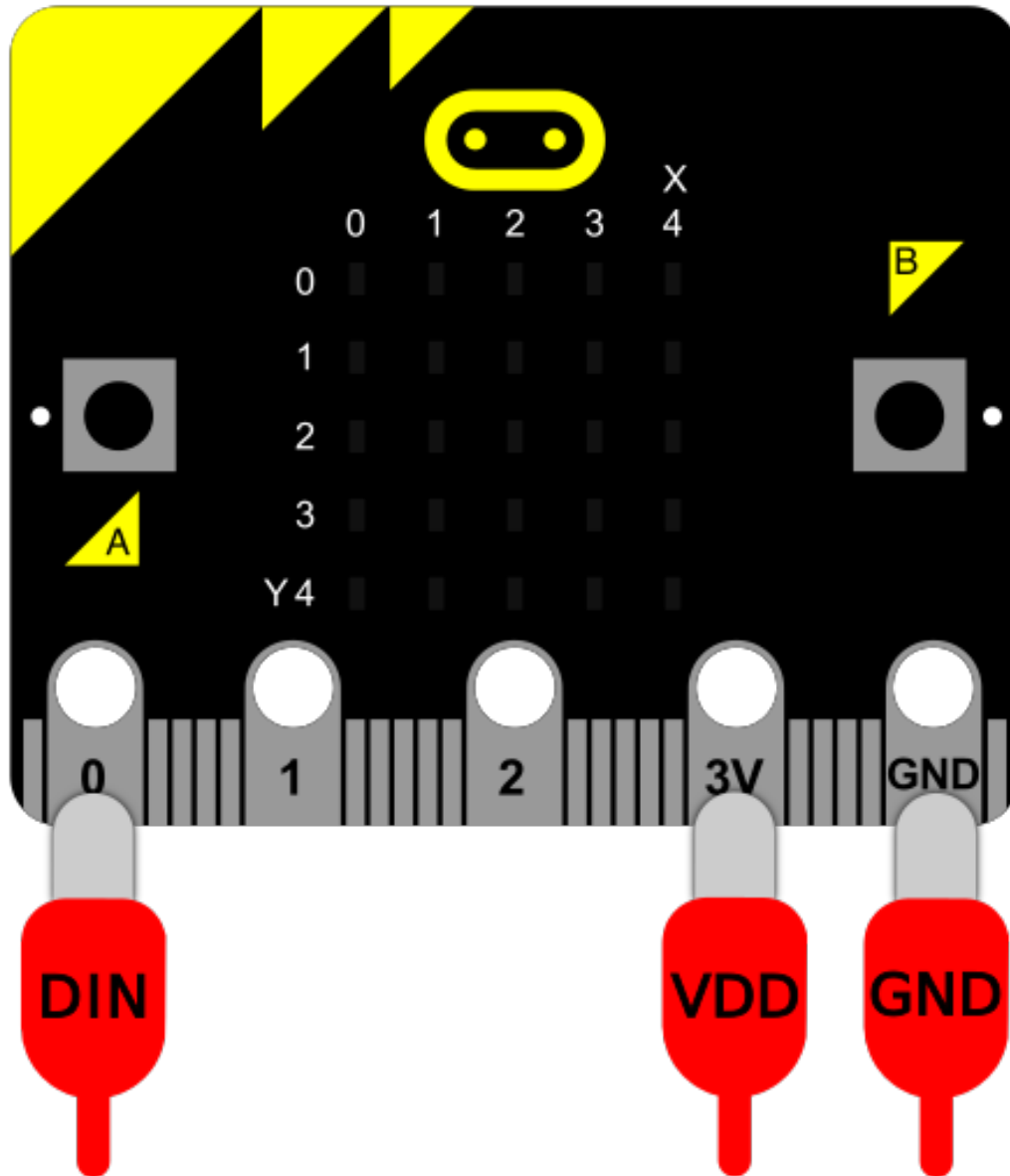

10.1 Classes

class `neopixel.NeoPixel` (*pin*, *n*)

Initialise a new strip of *n* number of neopixel LEDs controlled via pin *pin*. Each pixel is addressed by a position (starting from 0). Neopixels are given RGB (red, green, blue) values between 0-255 as a tuple. For example, (255, 255, 255) is white.

clear ()

Clear all the pixels.

show ()

Show the pixels. Must be called for any updates to become visible.

10.2 Operations

Writing the colour doesn't update the display (use `show()` for that).

```
np[0] = (255, 0, 128) # first element
np[-1] = (0, 255, 0) # last element
np.show() # only now will the updated value be shown
```

To read the colour of a specific pixel just reference it.

```
print(np[0])
```

10.3 Using Neopixels

Interact with Neopixels as if they were a list of tuples. Each tuple represents the RGB (red, green and blue) mix of colours for a specific pixel. The RGB values can range between 0 to 255.

For example, initialise a strip of 8 neopixels on a strip connected to pin0 like this:

```
import neopixel
np = neopixel.NeoPixel(pin0, 8)
```

Set pixels by indexing them (like with a Python list). For instance, to set the first pixel to full brightness red, you would use:

```
np[0] = (255, 0, 0)
```

Or the final pixel to purple:

```
np[-1] = (255, 0, 255)
```

Get the current colour value of a pixel by indexing it. For example, to print the first pixel's RGB value use:

```
print(np[0])
```

Finally, to push the new colour data to your Neopixel strip, use the `.show()` function:

```
np.show()
```

If nothing is happening, it's probably because you've forgotten this final step..!

Note: If you're not seeing anything change on your Neopixel strip, make sure you have `show()` at least somewhere otherwise your updates won't be shown.

10.4 Example

```
"""
    neopixel_random.py

    Repeatedly displays random colours onto the LED strip.
    This example requires a strip of 8 Neopixels (WS2812) connected to pin0.

    """
from microbit import *
import neopixel
from random import randint

# Setup the Neopixel strip on pin0 with a length of 8 pixels
np = neopixel.NeoPixel(pin0, 8)

while True:
    #Iterate over each LED in the strip

    for pixel_id in range(0, len(np)):
        red = randint(0, 60)
        green = randint(0, 60)
        blue = randint(0, 60)

        # Assign the current LED a random red, green and blue value between 0 and 60
        np[pixel_id] = (red, green, blue)

        # Display the current pixel data on the Neopixel strip
        np.show()
        sleep(100)
```

CHAPTER 11

The `os` Module

MicroPython contains an `os` module based upon the `os` module in the Python standard library. It's used for accessing what would traditionally be termed as operating system dependent functionality. Since there is no operating system in MicroPython the module provides functions relating to the management of the simple on-device persistent file system and information about the current system.

To access this module you need to:

```
import os
```

We assume you have done this for the examples below.

11.1 Functions

`os.listdir()`

Returns a list of the names of all the files contained within the local persistent on-device file system.

`os.remove(filename)`

Removes (deletes) the file named in the argument `filename`. If the file does not exist an `OSError` exception will occur.

`os.size(filename)`

Returns the size, in bytes, of the file named in the argument `filename`. If the file does not exist an `OSError` exception will occur.

`os.uname()`

Returns information identifying the current operating system. The return value is an object with five attributes:

- `sysname` - operating system name
- `nodename` - name of machine on network (implementation-defined)
- `release` - operating system release
- `version` - operating system version

- `machine` - hardware identifier

Note: There is no underlying operating system in MicroPython. As a result the information returned by the `uname` function is mostly useful for versioning details.

The `radio` module allows devices to work together via simple wireless networks.

The radio module is conceptually very simple:

- Broadcast messages are of a certain configurable length (up to 251 bytes).
- Messages received are read from a queue of configurable size (the larger the queue the more RAM is used). If the queue is full, new messages are ignored. Reading a message removes it from the queue.
- Messages are broadcast and received on a preselected channel (numbered 0-83).
- Broadcasts are at a certain level of power - more power means more range.
- Messages are filtered by address (like a house number) and group (like a named recipient at the specified address).
- The rate of throughput can be one of three pre-determined settings.
- Send and receive bytes to work with arbitrary data.
- Use `receive_full` to obtain full details about an incoming message: the data, receiving signal strength, and a microsecond timestamp when the message arrived.
- As a convenience for children, it's easy to send and receive messages as strings.
- The default configuration is both sensible and compatible with other platforms that target the BBC micro:bit.

To access this module you need to:

```
import radio
```

We assume you have done this for the examples below.

12.1 Constants

`radio.RATE_250KBIT`

Constant used to indicate a throughput of 256 Kbit a second.

`radio.RATE_1MBIT`

Constant used to indicate a throughput of 1 MBit a second.

`radio.RATE_2MBIT`

Constant used to indicate a throughput of 2 MBit a second.

12.2 Functions

`radio.on()`

Turns the radio on. This needs to be explicitly called since the radio draws power and takes up memory that you may otherwise need.

`radio.off()`

Turns off the radio, thus saving power and memory.

`radio.config(**kwargs)`

Configures various keyword based settings relating to the radio. The available settings and their sensible default values are listed below.

The `length` (default=32) defines the maximum length, in bytes, of a message sent via the radio. It can be up to 251 bytes long (254 - 3 bytes for S0, LENGTH and S1 preamble).

The `queue` (default=3) specifies the number of messages that can be stored on the incoming message queue. If there are no spaces left on the queue for incoming messages, then the incoming message is dropped.

The `channel` (default=7) can be an integer value from 0 to 83 (inclusive) that defines an arbitrary “channel” to which the radio is tuned. Messages will be sent via this channel and only messages received via this channel will be put onto the incoming message queue. Each step is 1MHz wide, based at 2400MHz.

The `power` (default=6) is an integer value from 0 to 7 (inclusive) to indicate the strength of signal used when broadcasting a message. The higher the value the stronger the signal, but the more power is consumed by the device. The numbering translates to positions in the following list of dBm (decibel milliwatt) values: -30, -20, -16, -12, -8, -4, 0, 4.

The `address` (default=0x75626974) is an arbitrary name, expressed as a 32-bit address, that’s used to filter incoming packets at the hardware level, keeping only those that match the address you set. The default used by other micro:bit related platforms is the default setting used here.

The `group` (default=0) is an 8-bit value (0-255) used with the `address` when filtering messages. Conceptually, “address” is like a house/office address and “group” is like the person at that address to which you want to send your message.

The `data_rate` (default=`radio.RATE_1MBIT`) indicates the speed at which data throughput takes place. Can be one of the following constants defined in the `radio` module : `RATE_250KBIT`, `RATE_1MBIT` or `RATE_2MBIT`.

If `config` is not called then the defaults described above are assumed.

`radio.reset()`

Reset the settings to their default values (as listed in the documentation for the `config` function above).

Note: None of the following send or receive methods will work until the radio is turned on.

`radio.send_bytes(message)`

Sends a message containing bytes.

`radio.receive_bytes()`

Receive the next incoming message on the message queue. Returns `None` if there are no pending messages. Messages are returned as bytes.

`radio.receive_bytes_into(buffer)`

Receive the next incoming message on the message queue. Copies the message into `buffer`, trimming the end of the message if necessary. Returns `None` if there are no pending messages, otherwise it returns the length of the message (which might be more than the length of the buffer).

`radio.send(message)`

Sends a message string. This is the equivalent of `send_bytes(bytes(message, 'utf8'))` but with `b'\x01\x00\x01'` prepended to the front (to make it compatible with other platforms that target the micro:bit).

`radio.receive()`

Works in exactly the same way as `receive_bytes` but returns whatever was sent.

Currently, it's equivalent to `str(receive_bytes(), 'utf8')` but with a check that the the first three bytes are `b'\x01\x00\x01'` (to make it compatible with other platforms that may target the micro:bit). It strips the prepended bytes before converting to a string.

A `ValueError` exception is raised if conversion to string fails.

`radio.receive_full()`

Returns a tuple containing three values representing the next incoming message on the message queue. If there are no pending messages then `None` is returned.

The three values in the tuple represent:

- the next incoming message on the message queue as bytes.
- the RSSI (signal strength): a value between 0 (strongest) and -255 (weakest) as measured in dBm.
- a microsecond timestamp: the value returned by `time.ticks_us()` when the message was received.

For example:

```
details = radio.receive_full()
if details:
    msg, rssi, timestamp = details
```

This function is useful for providing information needed for triangulation and/or trilateration with other micro:bit devices.

12.2.1 Examples

```
# A micro:bit Firefly.
# By Nicholas H.Tollervey. Released to the public domain.
import radio
import random
from microbit import display, Image, button_a, sleep

# Create the "flash" animation frames. Can you work out how it's done?
flash = [Image().invert()*(i/9) for i in range(9, -1, -1)]

# The radio won't work unless it's switched on.
radio.on()

# Event loop.
```

(continues on next page)

(continued from previous page)

```
while True:
    # Button A sends a "flash" message.
    if button_a.was_pressed():
        radio.send('flash') # a-ha
    # Read any incoming messages.
    incoming = radio.receive()
    if incoming == 'flash':
        # If there's an incoming "flash" message display
        # the firefly flash animation after a random short
        # pause.
        sleep(random.randint(50, 350))
        display.show(flash, delay=100, wait=False)
        # Randomly re-broadcast the flash message after a
        # slight delay.
        if random.randint(0, 9) == 0:
            sleep(500)
            radio.send('flash') # a-ha
```

Random Number Generation

This module is based upon the `random` module in the Python standard library. It contains functions for generating random behaviour.

To access this module you need to:

```
import random
```

We assume you have done this for the examples below.

13.1 Functions

`random.getrandbits` (*n*)

Returns an integer with *n* random bits.

Warning: Because the underlying generator function returns at most 30 bits, *n* may only be a value between 1-30 (inclusive).

`random.seed` (*n*)

Initialize the random number generator with a known integer *n*. This will give you reproducibly deterministic randomness from a given starting state (*n*).

`random.randint` (*a*, *b*)

Return a random integer *N* such that $a \leq N \leq b$. Alias for `randrange` (*a*, *b*+1).

`random.randrange` (*stop*)

Return a randomly selected integer between zero and up to (but not including) *stop*.

`random.randrange` (*start*, *stop*)

Return a randomly selected integer from `range` (*start*, *stop*).

`random.randrange` (*start*, *stop*, *step*)

Return a randomly selected element from `range` (*start*, *stop*, *step*).

`random.choice(seq)`

Return a random element from the non-empty sequence `seq`. If `seq` is empty, raises `IndexError`.

`random.random()`

Return the next random floating point number in the range `[0.0, 1.0)`

`random.uniform(a, b)`

Return a random floating point number `N` such that $a \leq N \leq b$ for $a \leq b$ and $b \leq N \leq a$ for $b < a$.

CHAPTER 14

Speech

Warning: WARNING! This is still work in progress; we reserve the right to change this API as development continues.

The quality of the speech is not great, merely “good enough”. Given the constraints of the device you may encounter memory errors and / or unexpected extra sounds during playback. It’s early days and we’re improving the code for the speech synthesiser all the time. Bug reports and pull requests are most welcome.

This module makes microbit talk, sing and make other speech like sounds provided that you connect a speaker to your board as shown below:

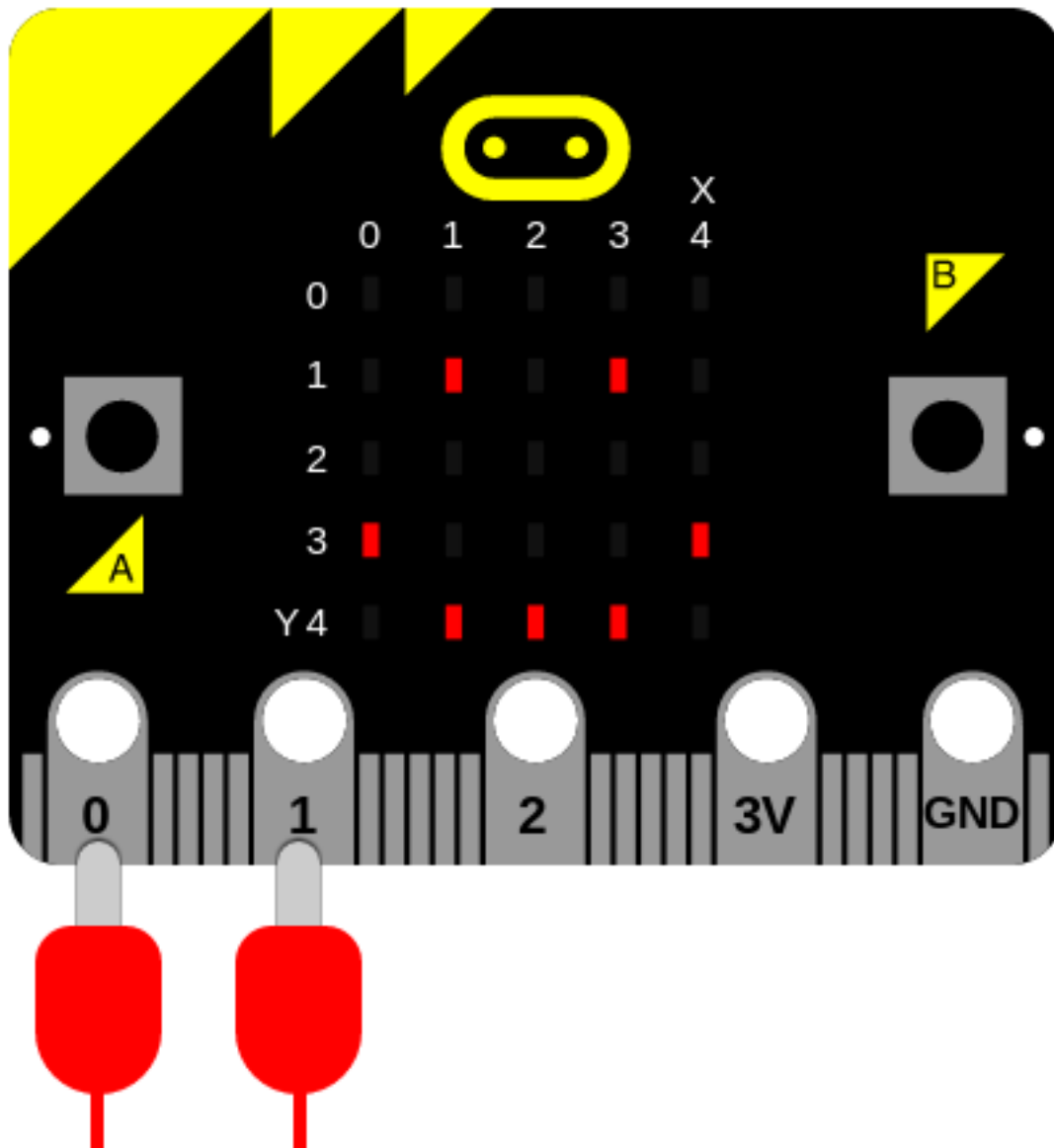

Note: This work is based upon the amazing reverse engineering efforts of Sebastian Macke based upon an old text-to-speech (TTS) program called SAM (Software Automated Mouth) originally released in 1982 for the Commodore 64. The result is a small C library that we have adopted and adapted for the micro:bit. You can find out more from [his homepage](#). Much of the information in this document was gleaned from the original user's manual which can be found [here](#).

The speech synthesiser can produce around 2.5 seconds worth of sound from up to 255 characters of textual input.

To access this module you need to:

```
import speech
```

We assume you have done this for the examples below.

14.1 Functions

`speech.translate` (*words*)

Given English words in the string `words`, return a string containing a best guess at the appropriate phonemes to pronounce. The output is generated from this [text to phoneme translation table](#).

This function should be used to generate a first approximation of phonemes that can be further hand-edited to improve accuracy, inflection and emphasis.

`speech.pronounce` (*phonemes*, *, *pitch=64*, *speed=72*, *mouth=128*, *throat=128*)

Pronounce the phonemes in the string `phonemes`. See below for details of how to use phonemes to finely control the output of the speech synthesiser. Override the optional pitch, speed, mouth and throat settings to change the timbre (quality) of the voice.

`speech.say` (*words*, *, *pitch=64*, *speed=72*, *mouth=128*, *throat=128*)

Say the English words in the string `words`. The result is semi-accurate for English. Override the optional pitch, speed, mouth and throat settings to change the timbre (quality) of the voice. This is a short-hand equivalent of: `speech.pronounce(speech.translate(words))`

`speech.sing` (*phonemes*, *, *pitch=64*, *speed=72*, *mouth=128*, *throat=128*)

Sing the phonemes contained in the string `phonemes`. Changing the pitch and duration of the note is described below. Override the optional pitch, speed, mouth and throat settings to change the timbre (quality) of the voice.

14.2 Punctuation

Punctuation is used to alter the delivery of speech. The synthesiser understands four punctuation marks: hyphen, comma, full-stop and question mark.

The hyphen (–) marks clause boundaries by inserting a short pause in the speech.

The comma (,) marks phrase boundaries and inserts a pause of approximately double that of the hyphen.

The full-stop (.) and question mark (?) end sentences.

The full-stop inserts a pause and causes the pitch to fall.

The question mark also inserts a pause but causes the pitch to rise. This works well with yes/no questions such as, “are we home yet?” rather than more complex questions such as “why are we going home?”. In the latter case, use a full-stop.

14.3 Timbre

The timbre of a sound is the quality of the sound. It’s the difference between the voice of a DALEK and the voice of a human (for example). To control the timbre change the numeric settings of the `pitch`, `speed`, `mouth` and `throat` arguments.

The pitch (how high or low the voice sounds) and speed (how quickly the speech is delivered) settings are rather obvious and generally fall into the following categories:

Pitch:

- 0-20 impractical
- 20-30 very high
- 30-40 high

- 40-50 high normal
- 50-70 normal
- 70-80 low normal
- 80-90 low
- 90-255 very low

(The default is 64)

Speed:

- 0-20 impractical
- 20-40 very fast
- 40-60 fast
- 60-70 fast conversational
- 70-75 normal conversational
- 75-90 narrative
- 90-100 slow
- 100-225 very slow

(The default is 72)

The mouth and throat values are a little harder to explain and the following descriptions are based upon our aural impressions of speech produced as the value of each setting is changed.

For mouth, the lower the number the more it sounds like the speaker is talking without moving their lips. In contrast, higher numbers (up to 255) make it sound like the speech is enunciated with exaggerated mouth movement.

For throat, the lower the number the more relaxed the speaker sounds. In contrast, the higher the number, the more tense the tone of voice becomes.

The important thing is to experiment and adjust the settings until you get the effect you desire.

To get you started here are some examples:

```
speech.say("I am a little robot", speed=92, pitch=60, throat=190, mouth=190)
speech.say("I am an elf", speed=72, pitch=64, throat=110, mouth=160)
speech.say("I am a news presenter", speed=82, pitch=72, throat=110, mouth=105)
speech.say("I am an old lady", speed=82, pitch=32, throat=145, mouth=145)
speech.say("I am E.T.", speed=100, pitch=64, throat=150, mouth=200)
speech.say("I am a DALEK - EXTERMINATE", speed=120, pitch=100, throat=100, mouth=200)
```

14.4 Phonemes

The `say` function makes it easy to produce speech - but often it's not accurate. To make sure the speech synthesiser pronounces things *exactly* how you'd like, you need to use phonemes: the smallest perceptually distinct units of sound that can be used to distinguish different words. Essentially, they are the building-block sounds of speech.

The `pronounce` function takes a string containing a simplified and readable version of the [International Phonetic Alphabet](#) and optional annotations to indicate inflection and emphasis.

The advantage of using phonemes is that you don't have to know how to spell! Rather, you only have to know how to say the word in order to spell it phonetically.

The table below lists the phonemes understood by the synthesiser.

Note: The table contains the phoneme as characters, and an example word. The example words have the sound of the phoneme (in parenthesis), but not necessarily the same letters.

Often overlooked: the symbol for the “H” sound is /H. A glottal stop is a forced stoppage of sound.

SIMPLE VOWELS		VOICED CONSONANTS	
IY	f (ee) t	R	(r) ed
IH	p (i) n	L	a (ll) ow
EH	b (e) g	W	a (w) ay
AE	S (a) m	W	(wh) ale
AA	p (o) t	Y	(y) ou
AH	b (u) dget	M	Sa (m)
AO	t (al) k	N	ma (n)
OH	c (o) ne	NX	so (ng)
UH	b (oo) k	B	(b) ad
UX	l (oo) t	D	(d) og
ER	b (ir) d	G	a (g) ain
AX	gall (o) n	J	(j) u (dg) e
IX	dig (i) t	Z	(z) oo
		ZH	plea (s) ure
DIPHTHONGS		V	se (v) en
EY	m (a) de	DH	(th) en
AY	h (igh)		
OY	b (oy)	UNVOICED CONSONANTS	
AW	h (ow)	S	(S) am
OW	sl (ow)	SH	fi (sh)
UW	cr (ew)	F	(f) ish
		TH	(th) in
SPECIAL PHONEMES		P	(p) oke
UL	sett (le) (=AXL)	T	(t) alk
UM	astron (om) y (=AXM)	K	(c) ake
UN	functi (on) (=AXN)	CH	spee (ch)
Q	kitt-en (glottal stop)	/H	a (h) ead

The following non-standard symbols are also available to the user:

YX	diphthong ending (weaker version of Y)
WX	diphthong ending (weaker version of W)
RX	R after a vowel (smooth version of R)
LX	L after a vowel (smooth version of L)
/X	H before a non-front vowel or consonant - as in (wh)o
DX	T as in pi(t)y (weaker version of T)

Here are some seldom used phoneme combinations (and suggested alternatives):

PHONEME COMBINATION	YOU PROBABLY WANT:	UNLESS IT SPLITS SYLLABLES LIKE:
GS	GZ e.g. ba (gs)	bu (gs) pray
BS	BZ e.g. slo (bz)	o (bsc) ene
DS	DZ e.g. su (ds)	Hu (ds) son
PZ	PS e.g. sla (ps)	-----
TZ	TS e.g. cur (ts) y	-----
KZ	KS e.g. fi (x)	-----

(continues on next page)

(continued from previous page)

NG	NXG e.g. singing	i (ng) rate
NK	NXK e.g. bank	Su (nk) ist

If you use anything other than the phonemes described above, a `ValueError` exception will be raised. Pass in the phonemes as a string like this:

```
speech.pronounce("/HEHLOW") # "Hello"
```

The phonemes are classified into two broad groups: vowels and consonants.

Vowels are further subdivided into simple vowels and diphthongs. Simple vowels don't change their sound as you say them whereas diphthongs start with one sound and end with another. For example, when you say the word "oil" the "oi" vowel starts with an "oh" sound but changes to an "ee" sound.

Consonants are also subdivided into two groups: voiced and unvoiced. Voiced consonants require the speaker to use their vocal chords to produce the sound. For example, consonants like "L", "N" and "Z" are voiced. Unvoiced consonants are produced by rushing air, such as "P", "T" and "SH".

Once you get used to it, the phoneme system is easy. To begin with some spellings may seem tricky (for example, "adventure" has a "CH" in it) but the rule is to write what you say, not what you spell. Experimentation is the best way to resolve problematic words.

It's also important that speech sounds natural and understandable. To help with improving the quality of spoken output it's often good to use the built-in stress system to add inflection or emphasis.

There are eight stress markers indicated by the numbers 1 - 8. Simply insert the required number after the vowel to be stressed. For example, the lack of expression of "/HEHLOW" is much improved (and friendlier) when spelled out "/HEH3LOW".

It's also possible to change the meaning of words through the way they are stressed. Consider the phrase "Why should I walk to the store?". It could be pronounced in several different ways:

```
# You need a reason to do it.
speech.pronounce("WAY2 SHUH7D AY WAO5K TUX DHAH STOHR.")
# You are reluctant to go.
speech.pronounce("WAY7 SHUH2D AY WAO7K TUX DHAH STOHR.")
# You want someone else to do it.
speech.pronounce("WAY5 SHUH7D AY2 WAO7K TUX DHAH STOHR.")
# You'd rather drive.
speech.pronounce("WAY5 SHUHD AY7 WAO2K TUX7 DHAH STOHR.")
# You want to walk somewhere else.
speech.pronounce("WAY5 SHUHD AY WAO5K TUX DHAH STOHR2OH7R.")
```

Put simply, different stresses in the speech create a more expressive tone of voice.

They work by raising or lowering pitch and elongating the associated vowel sound depending on the number you give:

1. very emotional stress
2. very emphatic stress
3. rather strong stress
4. ordinary stress
5. tight stress
6. neutral (no pitch change) stress
7. pitch-dropping stress
8. extreme pitch-dropping stress

The smaller the number, the more extreme the emphasis will be. However, such stress markers will help pronounce difficult words correctly. For example, if a syllable is not enunciated sufficiently, put in a neutral stress marker.

It's also possible to elongate words with stress markers:

```
speech.pronounce("/HEH5EH4EH3EH2EH2EH3EH4EH5EHLPL.")
```

14.5 Singing

It's possible to make MicroPython sing phonemes.

This is done by annotating a pitch related number onto a phoneme. The lower the number, the higher the pitch. Numbers roughly translate into musical notes as shown in the diagram below:

The diagram shows two musical staves. The first staff is a bass clef with notes and pitch numbers: 115 108 103 98 94 88 82 78 74 70 66 62. The second staff is a treble clef with notes and pitch numbers: 58 55 52 49 46 44 42 39 37 35 33 31 29 28 26 25 23 22 21 20.

Annotations work by pre-pending a hash (#) sign and the pitch number in front of the phoneme. The pitch will remain the same until a new annotation is given. For example, make MicroPython sing a scale like this:

```
solfa = [
    "#115DOWWWWWW", # Doh
    "#103REYYYYYY", # Re
    "#94MIYYYYYY", # Mi
    "#88FAOAOAOAOR", # Fa
    "#78SOHWWWWW", # Soh
    "#70LAOAOAOAOR", # La
    "#62TIYYYYYY", # Ti
    "#58DOWWWWWW", # Doh
]
song = ''.join(solfa)
speech.sing(song, speed=100)
```

In order to sing a note for a certain duration extend the note by repeating vowel or voiced consonant phonemes (as demonstrated in the example above). Beware diphthongs - to extend them you need to break them into their component parts. For example, “OY” can be extended with “OHOHIYIYIY”.

Experimentation, listening carefully and adjusting is the only sure way to work out how many times to repeat a phoneme so the note lasts for the desired duration.

14.6 How Does it Work?

The original manual explains it well:

First, instead of recording the actual speech waveform, we only store the frequency spectrums. By doing this, we save memory and pick up other advantages. Second, we [...] store some data about timing. These are numbers pertaining to the duration of each phoneme under different circumstances, and also some data on transition times so we can know how to blend a phoneme into its neighbors. Third, we devise a system of rules to deal with all this data and, much to our amazement, our computer is babbling in no time.

—S.A.M. owner’s manual.

The output is piped through the functions provided by the `audio` module and, hey presto, we have a talking micro:bit.

14.7 Example

```
import speech
from microbit import sleep

# The say method attempts to convert English into phonemes.
speech.say("I can sing!")
sleep(1000)
speech.say("Listen to me!")
sleep(1000)

# Clearing the throat requires the use of phonemes. Changing
# the pitch and speed also helps create the right effect.
speech.pronounce("AEAE/HAEMM", pitch=200, speed=100) # Ahem
sleep(1000)

# Singing requires a phoneme with an annotated pitch for each syllable.
solfa = [
    "#115DOWWWWWW", # Doh
    "#103REYYYYYY", # Re
    "#94MIYYYYYY", # Mi
    "#88FAOAOAOAOR", # Fa
    "#78SOHWWWWW", # Soh
    "#70LAOAOAOAOR", # La
    "#62TIYYYYYY", # Ti
    "#58DOWWWWWW", # Doh
]

# Sing the scale ascending in pitch.
song = ''.join(solfa)
speech.sing(song, speed=100)
# Reverse the list of syllables.
```

(continues on next page)

(continued from previous page)

```
solfa.reverse()
song = ''.join(solfa)
# Sing the scale descending in pitch.
speech.sing(song, speed=100)
```

The `utime` module provides functions for getting the current time and date, measuring time intervals, and for delays.

Note: The `utime` module is a MicroPython implementation of the standard Python `time` module. It can be imported using both `import utime` and `import time`, but the module is the same.

15.1 Functions

`utime.sleep(seconds)`

Sleep for the given number of seconds. You can use a floating-point number to sleep for a fractional number of seconds, or use the `utime.sleep_ms()` and `utime.sleep_us()` functions.

`utime.sleep_ms(ms)`

Delay for given number of milliseconds, should be positive or 0.

`utime.sleep_us(us)`

Delay for given number of microseconds, should be positive or 0.

`utime.ticks_ms()`

Returns an increasing millisecond counter with an arbitrary reference point, that wraps around after some value.

`utime.ticks_us()`

Just like `utime.ticks_ms()` above, but in microseconds.

`utime.ticks_add(ticks, delta)`

Offset ticks value by a given number, which can be either positive or negative. Given a ticks value, this function allows to calculate ticks value delta ticks before or after it, following modular-arithmetic definition of tick values.

Example:

```
# Find out what ticks value there was 100ms ago
print(ticks_add(time.ticks_ms(), -100))
```

(continues on next page)

(continued from previous page)

```
# Calculate deadline for operation and test for it
deadline = ticks_add(time.ticks_ms(), 200)
while ticks_diff(deadline, time.ticks_ms()) > 0:
    do_a_little_of_something()

# Find out TICKS_MAX used by this port
print(ticks_add(0, -1))
```

`utime.ticks_diff(ticks1, ticks2)`

Measure ticks difference between values returned from `utime.ticks_ms()` or `ticks_us()` functions, as a signed value which may wrap around.

The argument order is the same as for subtraction operator, `ticks_diff(ticks1, ticks2)` has the same meaning as `ticks1 - ticks2`.

`utime.ticks_diff()` is designed to accommodate various usage patterns, among them:

Polling with timeout. In this case, the order of events is known, and you will deal only with positive results of `utime.ticks_diff()`:

```
# Wait for GPIO pin to be asserted, but at most 500us
start = time.ticks_us()
while pin.value() == 0:
    if time.ticks_diff(time.ticks_us(), start) > 500:
        raise TimeoutError
```

Scheduling events. In this case, `utime.ticks_diff()` result may be negative if an event is overdue:

```
# This code snippet is not optimized
now = time.ticks_ms()
scheduled_time = task.scheduled_time()
if ticks_diff(scheduled_time, now) > 0:
    print("Too early, let's nap")
    sleep_ms(ticks_diff(scheduled_time, now))
    task.run()
elif ticks_diff(scheduled_time, now) == 0:
    print("Right at time!")
    task.run()
elif ticks_diff(scheduled_time, now) < 0:
    print("Oops, running late, tell task to run faster!")
    task.run(run_faster=True)
```

This section will help you set up the tools and programs needed for developing programs and firmware to flash to the BBC micro:bit using MicroPython.

16.1 Dependencies

16.2 Development Environment

You will need:

- git
- yotta

Depending on your operating system, the installation instructions vary. Use the installation scenario that best suits your system.

Yotta will require an ARM mbed account. It will walk you through signing up if you are not registered.

16.3 Installation Scenarios

- *Windows*
- *OS X*
- *Linux*
- *Debian and Ubuntu*
- *Red Hat Fedora/CentOS*
- *Raspberry Pi*

16.3.1 Windows

When installing [Yotta](#), make sure you have these components ticked to install.

- python
- gcc
- cMake
- ninja
- Yotta
- git-scm
- mbed serial driver

16.3.2 OS X

16.3.3 Linux

These steps will cover the basic flavors of Linux and working with the micro:bit and MicroPython. See also the specific sections for Raspberry Pi, Debian/Ubuntu, and Red Hat Fedora/Centos.

Debian and Ubuntu

```
sudo add-apt-repository -y ppa:team-gcc-arm-embedded
sudo add-apt-repository -y ppa:pmiller-opensource/ppa
sudo apt-get update
sudo apt-get install cmake ninja-build gcc-arm-none-eabi srecord libssl-dev
pip3 install yotta
```

Red Hat Fedora/CentOS

Raspberry Pi

16.4 Next steps

Congratulations. You have installed your development environment and are ready to begin *flashing firmware* to the micro:bit.

17.1 Building firmware

Use yotta to build.

Use target `bbc-microbit-classic-gcc-nosd`:

```
yt target bbc-microbit-classic-gcc-nosd
```

Run yotta update to fetch remote assets:

```
yt up
```

Start the build with either yotta:

```
yt build
```

... or use the Makefile:

```
make all
```

The result is a `microbit-micropython` hex file (i.e. `microbit-micropython.hex`) found in the `build/bbc-microbit-classic-gcc-nosd/source` from the root of the repository.

The Makefile does some extra preprocessing of the source, which is needed only if you add new interned strings to `qstrdefsport.h`. The Makefile also puts the resulting firmware at `build/firmware.hex`, and includes some convenience targets.

17.2 Preparing firmware and a Python program

`tools/makecombined`

`hexlify`

17.3 Flashing to the micro:bit

Installation Scenarios

- *Windows*
- *OS X*
- *Linux*
- *Debian and Ubuntu*
- *Red Hat Fedora/CentOS*
- *Raspberry Pi*

Accessing the REPL

REPL (Read-Evaluate-Print-Loop) allows the micro:bit to read and evaluate code in real-time as you write it.

Accessing the REPL on the micro:bit will require you to:

- Determine the communication port identifier for the micro:bit
- Use a program to establish communication with the device

For versions of Windows before 10 you might need to install the Mbed serial driver, the instructions for which are found here:

<https://os.mbed.com/docs/latest/tutorials/windows-serial-driver.html>

18.1 Using a serial communication program

The *Mu Editor* has built-in support for REPL and even includes a real-time data plotter. Some other common options are *picocom* and *screen*. You will need to install a program and read the appropriate documentation to understand the basics of connecting to a device.

18.2 Determining the port

The micro:bit will have a port identifier (tty, usb) that can be used by the computer for communicating. Before connecting to the micro:bit we must determine the port identifier.

Windows

When you have installed the aforementioned drivers the micro:bit will appear in device-manager as a COM port.

Mac OS

Open Terminal and type `ls /dev/cu.*` to see a list of connected serial devices; one of them will look like `/dev/cu.usbmodem1422` (the exact number will depend on your computer).

Linux

In terminal, type `dmesg | tail` which will show which `/dev` node the micro:bit was assigned (e.g. `/dev/ttyUSB0`).

18.3 Communicating with the micro:bit

Once you have found the port identifier you can use a serial terminal program to communicate with the micro:bit.

Windows

You may wish to use Tera Term, PuTTY, or another program.

In Tera Term:

- Plug in the micro:bit and open Tera Term
- Select Serial as the port
- Go to Setup -> Serial port. Ensure the Port is the correct COM port.
- Choose a baud rate of 115200, data 8 bits, parity none, stop 1 bit.

In PuTTY:

- Plug in the micro:bit and open PuTTY
- Switch the Connection Type to Serial
- Ensure the Port is the correct COM port
- Change the baud rate to 115200
- Select 'Serial' on the menu on the left, then click 'Open'

Mac OS

Open Terminal and type `screen /dev/cu.usbmodem1422 115200`, replacing `/dev/cu.usbmodem1422` with the port you found earlier. This will open the micro:bit's serial output and show all messages received from the device.

To exit, press Ctrl-A then Ctrl-\ and answer Yes to the question. There are many ways back to a command prompt including Ctrl-A then Ctrl-D, which will detach screen, but the serial port will still be locked, preventing other applications from accessing it. You can then restart screen by typing `screen -r`.

Linux

Using the screen program, type `screen /dev/ttyUSB0 115200`, replacing `/dev/ttyUSB0` with the port you found earlier.

To exit, press Ctrl-A then \ and answer Yes to the question. There are many ways back to a command prompt including Ctrl-A then Ctrl-D, which will detach screen. All serial output from the micro:bit will still be received by screen, the serial port will be locked, preventing other applications from accessing it. You can restart screen by typing `screen -r`.

Using picocom, type `picocom /dev/ttyACM0 -b 115200`, again replacing `/dev/ttyACM0` with the port you found earlier.

To exit, press Ctrl-A then Ctrl-Q.

CHAPTER 19

Firmware Hex File

When MicroPython is built, the compiler produces an [Intel Hex](#) file containing the MicroPython firmware. Additional data can then be added to this file to contain information about the MicroPython version, or the Python code to execute on start-up.

The general memory layout used is:

- 0x00000000: Start of MicroPython firmware - up to 248 KBs
- 0x0003e000: Start of appended script (optional) - up to 8 Kbs
- 0x100010c0: UICR customer[16] register, start of MicroPython information - 28 bytes

Note: If you append any data or modify the Intel Hex file, please ensure the addresses of the data stored progress in incremental order. If there is an address jump backwards DAPLink will fail to flash the file.

19.1 Appended script format

MicroPython checks the first 2 bytes at address 0x0003e000 for a magic string to indicate if there is an appended script. If the magic string is found, it will automatically execute the Python code stored there, unless there is a main.py file stored in the MicroPython filesystem.

- 0x0003e000: 2 bytes “MP”
- 0x0003e002: 2 bytes, little endian integer for the length (in bytes) of the appended script (not counting this 4 byte header)
- 0x0003e004: Script stored as bytes, for MicroPython to decode using utf-8.

19.2 UICR format

The User Information Configuration Registers (UICR) is a region of Non-Volatile Memory available to store user-specific settings. The first 128 Bytes are reserved, but we can use the other 128 Bytes to store any arbitrary data.

MicroPython stores the following information, in little endian, starting from the UICR customer[16] register:

- `0x100010c0`: 4-byte integer with magic value `0x17eeb07c`
- `0x100010c4`: 4-byte integer with value `0xffffffff`
- `0x100010c8`: 4-byte integer with value `0x0000000a` (log base 2 of the flash page size, being 1024 bytes)
- `0x100010ca`: 2-byte integer with value `0x0000` (start page of the firmware)
- `0x100010cc`: 2-byte integer storing number of pages used by the firmware
- `0x100010d0`: 4-byte integer with value `0xffffffff`
- `0x100010d4`: 4-byte integer with the address in the firmware of the version string
- `0x100010d8`: 4-byte integer with value `0x00000000`

19.3 Steps to create the firmware.hex file

The yotta tool is used to build MicroPython, but before that takes place additional files have to be generated by the Makefile in preparation for the build, and additional data is added to the hex file after.

Running the `make all` command executes the following steps:

- The `tools/makeversionhdr.py` script creates the `microbitversion.h` file with macros containing build information
- Yotta builds the source and creates a bare hex file with just the firmware
- The `tools/adduicr.py` script adds the UICR to the bare hex
- The final hex file is placed in `build/firmware.hex`
- The user can optionally append a script using `tools/makecombinedhex.py` (or other tools)

CHAPTER 20

Developer FAQ

Note: This project is under active development. Please help other developers by adding tips, how-tos, and Q&A to this document. Thanks!

Where do I get a copy of the DAL? A: Ask Nicholas Tollervey for details.

Hey! Many thanks for wanting to improve MicroPython on the micro:bit.

Contributions are welcome without prejudice from *anyone* irrespective of age, gender, religion, race or sexuality. Good quality code and engagement with respect, humour and intelligence wins every time.

- If you're from a background which isn't well-represented in most geeky groups, get involved - *we want to help you make a difference.*
- If you're from a background which *is* well-represented in most geeky groups, get involved - *we want your help making a difference.*
- If you're worried about not being technical enough, get involved - *your fresh perspective will be invaluable.*
- If you think you're an imposter, get involved.
- If your day job isn't code, get involved.
- This isn't a group of experts, just people. Get involved!
- This is a new community, so, get involved.

We expect contributors to follow the Python Software Foundation's Code of Conduct: <https://www.python.org/psf/codeofconduct/>

Feedback may be given for contributions and, where necessary, changes will be politely requested and discussed with the originating author. Respectful yet robust argument is most welcome.

21.1 Checklist

- Your code should be commented in *plain English* (British spelling).
- If your contribution is for a major block of work and you've not done so already, add yourself to the AUTHORS file following the convention found therein.
- If in doubt, ask a question. The only stupid question is the one that's never asked.
- Have fun!

- [genindex](#)
- [modindex](#)
- [search](#)

a

audio, 75

m

machine, 83

microbit, 54

microbit.accelerometer, 68

microbit.compass, 72

microbit.display, 63

microbit.i2c, 67

microbit.spi, 66

microbit.uart, 64

micropython, 85

music, 87

n

neopixel, 93

o

os, 97

r

radio, 99

random, 103

s

speech, 105

u

utime, 115

A

any() (*microbit.uart.uart method*), 65
 audio (*module*), 75
 AudioFrame (*class in audio*), 75

B

blit() (*microbit.Image method*), 61
 Button (*built-in class*), 54
 button_a, 54
 button_b, 54
 BytesIO (*built-in class*), 82

C

calibrate() (*in module microbit.compass*), 72
 choice() (*in module random*), 103
 clear() (*in module microbit.display*), 63
 clear() (*neopixel.NeoPixel method*), 94
 clear_calibration() (*in module microbit.compass*), 72
 close() (*BytesIO method*), 82
 config() (*in module radio*), 100
 copy() (*microbit.Image method*), 61
 crop() (*microbit.Image method*), 60
 current_gesture() (*in module microbit.accelerometer*), 68

D

disable_irq() (*machine.machine method*), 83

E

enable_irq() (*machine.machine method*), 83

F

fill() (*microbit.Image method*), 61
 freq() (*machine.machine method*), 83

G

get_field_strength() (*in module microbit.compass*), 72

get_gestures() (*in module microbit.accelerometer*), 68
 get_pixel() (*in module microbit.display*), 63
 get_pixel() (*microbit.Image method*), 60
 get_presses() (*Button method*), 54
 get_tempo() (*in module music*), 89
 get_values() (*in module microbit.accelerometer*), 68
 get_x() (*in module microbit.accelerometer*), 68
 get_x() (*in module microbit.compass*), 72
 get_y() (*in module microbit.accelerometer*), 68
 get_y() (*in module microbit.compass*), 72
 get_z() (*in module microbit.accelerometer*), 68
 get_z() (*in module microbit.compass*), 72
 getrandbits() (*in module random*), 103

H

heading() (*in module microbit.compass*), 72
 height() (*microbit.Image method*), 60

I

Image (*class in microbit*), 59
 init() (*in module microbit.i2c*), 67
 init() (*in module microbit.spi*), 66
 init() (*in module microbit.uart*), 64
 invert() (*microbit.Image method*), 61
 is_calibrated() (*in module microbit.compass*), 72
 is_gesture() (*in module microbit.accelerometer*), 68
 is_on() (*in module microbit.display*), 64
 is_pressed() (*Button method*), 54
 is_touched() (*microbit.MicroBitTouchPin method*), 58

L

listdir() (*in module os*), 97

M

machine (*module*), 83
 microbit (*module*), 53, 54, 59
 microbit.accelerometer (*module*), 68

`microbit.compass` (module), 72
`microbit.display` (module), 63
`microbit.i2c` (module), 67
`microbit.spi` (module), 66
`microbit.uart` (module), 64
`MicroBitAnalogDigitalPin` (class in `microbit`), 58
`MicroBitDigitalPin` (class in `microbit`), 57
`MicroBitTouchPin` (class in `microbit`), 58
`micropython` (module), 85
`micropython.const()` (in module `micropython`), 85
`micropython.heap_lock()` (in module `micropython`), 86
`micropython.heap_unlock()` (in module `micropython`), 86
`micropython.kbd_intr()` (in module `micropython`), 86
`micropython.mem_info()` (in module `micropython`), 85
`micropython.opt_level()` (in module `micropython`), 85
`micropython.qstr_info()` (in module `micropython`), 86
`micropython.stack_use()` (in module `micropython`), 86
`music` (module), 87

N

`name()` (BytesIO method), 82
`NeoPixel` (class in `neopixel`), 94
`neopixel` (module), 93

O

`off()` (in module `microbit.display`), 64
`off()` (in module `radio`), 100
`on()` (in module `microbit.display`), 64
`on()` (in module `radio`), 100
`open()` (built-in function), 82
`os` (module), 97

P

`panic()` (in module `microbit`), 53
`pitch()` (in module `music`), 89
`play()` (in module `audio`), 75
`play()` (in module `music`), 89
`pronounce()` (in module `speech`), 107

R

`radio` (module), 99
`randint()` (in module `random`), 103
`random` (module), 103
`random()` (in module `random`), 104
`randrange()` (in module `random`), 103

`RATE_1MBIT` (in module `radio`), 99
`RATE_250KBIT` (in module `radio`), 99
`RATE_2MBIT` (in module `radio`), 100
`read()` (BytesIO method), 82
`read()` (in module `microbit.i2c`), 67
`read()` (`microbit.spi.spi` method), 67
`read()` (`microbit.uart.uart` method), 65
`read_analog()` (`microbit.MicroBitAnalogDigitalPin` method), 58
`read_digital()` (`microbit.MicroBitDigitalPin` method), 57
`read_light_level()` (in module `microbit.display`), 64
`readall()` (`microbit.uart.uart` method), 65
`readinto()` (BytesIO method), 82
`readinto()` (`microbit.uart.uart` method), 66
`readline()` (BytesIO method), 82
`readline()` (`microbit.uart.uart` method), 66
`receive()` (in module `radio`), 101
`receive_bytes()` (in module `radio`), 100
`receive_bytes_into()` (in module `radio`), 101
`receive_full()` (in module `radio`), 101
`remove()` (in module `os`), 97
`reset()` (in module `microbit`), 53
`reset()` (in module `music`), 90
`reset()` (in module `radio`), 100
`reset()` (`machine.machine` method), 83
`running_time()` (in module `microbit`), 53

S

`say()` (in module `speech`), 107
`scan()` (in module `microbit.i2c`), 67
`scroll()` (in module `microbit.display`), 63
`seed()` (in module `random`), 103
`send()` (in module `radio`), 101
`send_bytes()` (in module `radio`), 100
`set_analog_period()` (`microbit.MicroBitAnalogDigitalPin` method), 58
`set_analog_period_microseconds()` (`microbit.MicroBitAnalogDigitalPin` method), 58
`set_pixel()` (in module `microbit.display`), 63
`set_pixel()` (`microbit.Image` method), 60
`set_tempo()` (in module `music`), 89
`shift_down()` (`microbit.Image` method), 60
`shift_left()` (`microbit.Image` method), 60
`shift_right()` (`microbit.Image` method), 60
`shift_up()` (`microbit.Image` method), 60
`show()` (in module `microbit.display`), 63
`show()` (`neopixel.NeoPixel` method), 94
`sing()` (in module `speech`), 107
`size()` (in module `os`), 97
`sleep()` (in module `microbit`), 53
`sleep()` (`utime.utime` method), 115
`sleep_ms()` (`utime.utime` method), 115

`sleep_us()` (*utime.utime method*), 115
`speech` (*module*), 105
`stop()` (*in module music*), 90

T

`temperature()` (*in module microbit*), 53
`TextIO` (*built-in class*), 82
`ticks_add()` (*utime.utime method*), 115
`ticks_diff()` (*utime.utime method*), 116
`ticks_ms()` (*utime.utime method*), 115
`ticks_us()` (*utime.utime method*), 115
`time_pulse_us()` (*machine.machine method*), 83
`translate()` (*in module speech*), 107

U

`uname()` (*in module os*), 97
`uniform()` (*in module random*), 104
`unique_id()` (*machine.machine method*), 83
`utime` (*module*), 115

W

`was_gesture()` (*in module microbit.accelerometer*),
68
`was_pressed()` (*Button method*), 54
`width()` (*microbit.Image method*), 60
`writable()` (*BytesIO method*), 82
`write()` (*BytesIO method*), 82
`write()` (*in module microbit.i2c*), 67
`write()` (*microbit.spi.spi method*), 67
`write()` (*microbit.uart.uart method*), 66
`write_analog()` (*micro-
bit.MicroBitAnalogDigitalPin method*), 58
`write_digital()` (*microbit.MicroBitDigitalPin
method*), 58
`write_readinto()` (*microbit.spi.spi method*), 67